



**HAL**  
open science

## Neural inversion of flight guidance dynamics

Wen Chi Lu, Roger Faye, Alexandre Carlos Brandao-Ramos, Jules Ghislain Slama, Felix Mora-Camino

► **To cite this version:**

Wen Chi Lu, Roger Faye, Alexandre Carlos Brandao-Ramos, Jules Ghislain Slama, Felix Mora-Camino. Neural inversion of flight guidance dynamics. ISDA 2007, 7th International Conference on Intelligent Systems Design and Applications, Oct 2007, Rio de Janeiro, Brazil. pp 190-195, 10.1109/ISDA.2007.58 . hal-00938898

**HAL Id: hal-00938898**

**<https://hal-enac.archives-ouvertes.fr/hal-00938898>**

Submitted on 23 Jun 2014

**HAL** is a multi-disciplinary open access archive for the deposit and dissemination of scientific research documents, whether they are published or not. The documents may come from teaching and research institutions in France or abroad, or from public or private research centers.

L'archive ouverte pluridisciplinaire **HAL**, est destinée au dépôt et à la diffusion de documents scientifiques de niveau recherche, publiés ou non, émanant des établissements d'enseignement et de recherche français ou étrangers, des laboratoires publics ou privés.

## Neural Inversion of Flight Guidance Dynamics

W.C. Lu<sup>1</sup>, R.M. Faye<sup>3</sup>, A.C. Brandão Ramos<sup>4</sup>, J. Slama<sup>5</sup>, F. Mora-Camino<sup>2</sup>

<sup>1</sup>RMRL, National Cheng Kung University, Tainan, Taiwan

<sup>2</sup>LARA, ENAC, Toulouse, France

<sup>3</sup>Ecole Supérieure Polytechnique, UCAD, Dakar, Sénégal

<sup>4</sup>Instituto de Ciências Exatas, UNIFEI, Itajubá, Brazil

<sup>5</sup>Programa de Engenharia Mecânica, COPPE/UFRJ, Rio de Janeiro, Brazil

luwenchi@mail.ncku.edu.tw, rmfaye@ucad.sn, ramos@unifei.edu.br, jules@rionet.com.br, felix.mora@enac.fr

### Abstract

*Differential flatness, a property of some dynamic systems which has been recognized only recently, has made possible the development of new tools to control complex nonlinear dynamic systems. Many dynamic non linear systems have been proved to be differentially flat. In this paper, it is shown that the inertial position coordinates of an aircraft can be considered as differential flat outputs for its flight guidance dynamics. Since this differential flatness property is implicit, a neural network is introduced, as a numerical device, to deal with the inversion of the guidance dynamics. Then, once conveniently structured and trained, a neural network is able to generate in real time directives to conventional autopilot systems so that a reference trajectory can be tracked. Numerical results relative to the training of the neural network and to trajectory tracking are displayed and discussed.*

### 1. Introduction

The sustained increase of air transportation over the last decades has led to traffic saturated situations, then new maneuvering capabilities are needed for civil aviation aircraft to ensure safety as well as efficiency in air transportation operations. Differential geometry has allowed the development of new approaches for the control of nonlinear systems. Their applicability to flight dynamics, which are essentially nonlinear, appears of interest since previous flight control functions have been mainly based on empiricism and cumbersome gain scheduling linear control laws.

Differential flatness, a concept introduced by the school of Fontainebleau (Fliess, et al. 1995), has provided new opportunities to design advanced control and supervision schemes for non linear systems. According to this theory, given a desired trajectory for a flat output, it becomes quite easy to derive the corresponding input. Some authors have already given insight into the differential flatness of aircraft flight dynamics (Lavigne, et al. 2003; Martin, 1992; Lu, et al. 2004). None of them has considered specifically the flatness property of the flight guidance dynamics for a rigid aircraft and its potential applications to trajectory tracking.

In this communication, first a proof of the implicit differential flatness of flight guidance dynamics is displayed. To make this property valuable for real time applications, a feed-forward neural networks structure is proposed to invert the flight guidance dynamics. Issues related with the effective training of such a structure are discussed and numerical results, relative to a reference aircraft model are displayed. These results show that the proposed approach allows the identification of the flatness property of flight guidance dynamics, resulting in a numerical tool for new trajectory tracking applications.

### 2. Differential Flatness

Here two definitions of differential flatness are introduced: one relative to systems for which causal relationships of interest are displayed analytically, and another one where these causal relationships are introduced through implicit functions.

Definition 1: A general nonlinear system whose dynamics are given by:

$$\dot{\underline{X}} = F(\underline{X}, \underline{U}) \quad \underline{X} \in \mathbf{R}^n, \underline{U} \in \mathbf{R}^m \quad (1)$$

where  $F$  is a smooth mapping, is said explicitly flat with respect to the output vector  $\underline{Z}$ , if  $\underline{Z}$  is an  $m^{\text{th}}$  order vector which can be expressed analytically as a function of the current state, the current input and its derivatives and also such as the state and the input vectors can be expressed analytically as a function of  $\underline{Z}$  and its derivatives.

Then there exists smooth mappings  $G_X$ ,  $G_U$  and  $G_Z$  such as:

$$\underline{Z} = G_Z(\underline{X}, \underline{U}, \dots, \underline{U}^{(p)}) \quad (2-a)$$

$$\underline{X} = G_X(\underline{Z}, \underline{\dot{Z}}, \dots, \underline{Z}^{(q)}) \quad (2-b)$$

$$\underline{U} = G_U(\underline{Z}, \underline{\dot{Z}}, \dots, \underline{Z}^{(q+1)}) \quad (2-c)$$

where  $p$  and  $q$  are integer numbers. Vector  $\underline{Z}$  is called a flat output for the nonlinear system. Although there is no systematical way to determine the flat output, the components of the flat output usually possess some physical meanings.

The explicit flatness property is of particular interest for the solution of a control problem when a physically meaningful flat output can be related with its objectives: for instance, in many situations, the control problem can be formulated as a flat output trajectory tracking problem.

However, for many systems, no complete analytical models are available to describe their full dynamics. Some of their components make use of input-output numerical devices derived both from theory and from experimental data. In these cases, the available theory provides in general the main mathematical properties of these implicit functions while experimental data is used to build accurate input output numerical devices. This happens for instance when flight dynamics modeling is considered either for control or simulation purposes, since in practice the aerodynamic coefficients are obtained through interpolation across large sets of look-up tables.

Definition 2: A nonlinear system given by a general implicit nth order state representation:

$$F(\underline{X}, \dot{\underline{X}}, \underline{U}) = 0, \quad \underline{X} \in \mathbf{R}^n, \underline{U} \in \mathbf{R}^m \quad (3)$$

where  $F$  is a regular implicit mapping with respect to  $\dot{\underline{X}}$ , is said implicitly flat over an interior non-empty domain  $\Delta \subseteq \mathbf{R}^{n+m}$  if it is possible to find an  $m^{\text{th}}$  order vector  $\underline{Z}$  which meets condition Eq.(1), Eq.(2-a) and condition:

$$G(\underline{X}, \underline{U}, \underline{Z}, \underline{\dot{Z}}, \dots, \underline{Z}^{(r)}) = 0 \quad (4)$$

where  $G$  is locally invertible over  $\Delta$  with respect to  $\underline{X}$  and  $\underline{U}$  where  $r$  is an integer. Again, vector  $\underline{Z}$  is said to be a flat output.

The local invertibility of  $G$  is guaranteed if the determinant of the Jacobian of  $G$  is not zero according to the theorem of implicit functions, i.e. if:

$$\det\left(\frac{\partial G}{\partial(\underline{X}, \underline{U})}\right) \neq 0 \quad (5)$$

In this case, given a trajectory of the flat output  $\underline{Z}$ , it is possible to map it numerically into the input space to derive corresponding control signals, so that one of the more interesting properties of differentially flat systems is still maintained.

### 3. Flight Guidance Dynamics

In this study, only the guidance dynamics of transportation aircraft, i.e. the temporal trajectory followed by its center of gravity, are considered.

It is assumed that the aircraft is equipped with a basic autopilot which deals efficiently with its fast dynamics and controls its attitude angles  $(\theta, \phi, \psi)$  as well as its thrust regime  $\Omega$ .

It is also supposed that their yaw damper can achieve perfect coordinated-turn motion, so that  $\beta$  is supposed to remain very small.

Here the flight variables  $\theta$ ,  $\phi$  and  $\Omega$  are taken as the inputs for the guidance dynamics as well as the outputs for the fast dynamics around the aircraft body frame when controlled by a basic auto pilot.

Figure 1 displays the resulting structure for the whole flight dynamics.

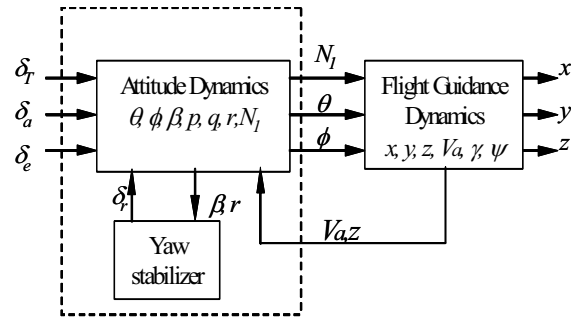

Figure 1. Aircraft Flight Dynamics Structure

Equations (6-a, 6-b and 6-c) express, in steady wind conditions, the flight guidance dynamics in the aerodynamics reference frame (Lu, et al. 2004a).

$$\dot{x} = V_a \cos \psi \cos \gamma + w_x \quad (6-a)$$

$$\dot{y} = V_a \sin \psi \cos \gamma + w_y \quad (6-b)$$

$$\dot{z} = -V_a \sin \gamma + w_z \quad (6-c)$$

with:

$$V_a = \sqrt{(\dot{x} - w_x)^2 + (\dot{y} - w_y)^2 + (\dot{z} - w_z)^2} \quad (7)$$

$$\dot{V}_a = \frac{-D + T \cos \alpha - mg(-\cos \alpha \sin \theta + \sin \alpha \cos \phi \cos \theta)}{m} \quad (8)$$

$$\dot{\gamma} = \frac{L \cos \phi + T \sin \alpha - mg(\sin \alpha \sin \theta + \cos \alpha \cos \phi \cos \theta)}{m V_a} \quad (9)$$

In coordinated-turn maneuver, the heading rate is related to the bank angle  $\phi$  through the following relation:

$$\dot{\psi} = (g/V) \tan \phi \quad (10)$$

The drag force  $D$  and lift force  $L$  are respectively considered to be functions of altitude  $z$ , airspeed  $V_a$  and angle-of-attack  $\alpha$ . While the thrust  $T$  can be considered to be functions of altitude  $z$ , airspeed  $V_a$  and engine regime  $\Omega$ .

$$D = D(z, V_a, \alpha), \quad L = L(z, V_a, \alpha), \quad T = T(z, V_a, N_1) \quad (11)$$

For local guidance purposes, the flight-path angle  $\gamma$  is usually taken as the control parameter. Once the bank angle is considered to be small enough, the angle-of-attack can be expressed in:

$$\alpha = \theta - \gamma \quad (12)$$

#### 4. Flatness of the Flight Guidance Dynamics

Here it is shown how, starting from the knowledge of  $x(t)$ ,  $y(t)$  and  $z(t)$ , it is possible to express successively all the guidance variables as a function of them and their derivatives. By rearranging the kinematical equations (Equations 6-a, 6-b and 6-c) are expressed as:

$$\gamma = -\sin^{-1}(\dot{z}/V) \quad (13)$$

$$\psi = \tan^{-1}(\dot{y}/\dot{x}) \quad (14)$$

The state variables  $V_a$ ,  $\gamma$  and  $\psi$ , obviously can be functions of the inertial position of aircraft while the control variables satisfy the following relations:

$$\dot{V}_a - \frac{-D + T \cos \alpha - mg(-\cos \alpha \sin \theta + \sin \alpha \cos \phi \cos \theta)}{m} = 0 \quad (15-a)$$

$$\dot{\gamma} - \frac{L \cos \phi + T \sin \alpha - mg(\sin \alpha \sin \theta + \cos \alpha \cos \phi \cos \theta)}{m V_a} = 0 \quad (15-b)$$

$$\dot{\psi} - \left(\frac{g}{V}\right) \tan \phi = 0 \quad (15-c)$$

where  $\alpha$  can be replaced by a function of  $\phi$ ,  $\theta$  and  $\gamma$  given in Equation (12).

The following notations are adopted for the position of the center of gravity of the aircraft and for the guidance inputs:

$$\underline{Z} = (x, y, z)^T \quad \text{and} \quad \underline{U} = (\theta, \phi, N_1) \quad (16)$$

Once the variables in Eq.(15-a), Eq.(15-b) and Eq.(15-c) are replaced by their expressions in  $\underline{Z}$  and its first two derivatives, these equations can be rewritten as:

$$\begin{cases} G_{N_1}(\underline{Z}, \dot{\underline{Z}}, \ddot{\underline{Z}}, \underline{U}) = 0 & (17-a) \\ G_{\theta}(\underline{Z}, \dot{\underline{Z}}, \ddot{\underline{Z}}, \underline{U}) = 0 & (17-b) \\ G_{\phi}(\underline{Z}, \dot{\underline{Z}}, \ddot{\underline{Z}}, \underline{U}) = 0 & (17-c) \end{cases}$$

These implicit functions are locally invertible with respect to the input vector since for normal flight conditions the determinant of their Jacobian is not zero (Lu, et al. 2004):

$$\begin{vmatrix} \frac{\partial G_{N_1}}{\partial \theta} & \frac{\partial G_{N_1}}{\partial \phi} & \frac{\partial G_{N_1}}{\partial N_1} \\ \frac{\partial G_{\theta}}{\partial \theta} & \frac{\partial G_{\theta}}{\partial \phi} & \frac{\partial G_{\theta}}{\partial N_1} \\ \frac{\partial G_{\phi}}{\partial \theta} & \frac{\partial G_{\phi}}{\partial \phi} & \frac{\partial G_{\phi}}{\partial N_1} \end{vmatrix} \neq 0 \quad (18)$$

Then,  $\underline{Z} = (x, y, z)^T$  is a flat output vector for the considered flight guidance dynamics. The time evolution of these flat outputs represents the trajectory followed by the center of gravity of the aircraft. Then according to the above theory, from the knowledge of this trajectory, it should be possible to find the corresponding inputs.

#### 5. Neural Identification of Implicit Flatness

As a consequence of the above flatness property, given a smooth reference trajectory for the flat outputs such as:

$$\underline{Z}_c(\tau) = (x_c(\tau), y_c(\tau), z_c(\tau))^T, \quad \tau \in [t_0, t] \quad (19)$$

The corresponding reference input values at the instant  $t$ ,  $U_c(t) = (\phi_c(t), \theta_c(t), N_{1c}(t))^T$  are solutions of the set of equations:

$$\begin{cases} G_{N_1}(\underline{Z}_c(t), \dot{\underline{Z}}_c(t), \ddot{\underline{Z}}_c(t), \underline{U}_c(t)) = 0 & (20\text{-a}) \\ G_{\theta}(\underline{Z}_c(t), \dot{\underline{Z}}_c(t), \ddot{\underline{Z}}_c(t), \underline{U}_c(t)) = 0 & (20\text{-b}) \\ G_{\phi}(\underline{Z}_c(t), \dot{\underline{Z}}_c(t), \ddot{\underline{Z}}_c(t), \underline{U}_c(t)) = 0 & (20\text{-c}) \end{cases}$$

where  $\underline{z}_c(t)$ ,  $\dot{\underline{z}}_c(t)$  and  $\ddot{\underline{z}}_c(t)$  are the current parameters.

In general, it will be very difficult to get an on-line numerical solution to this set of implicit equations, so it is useful to get an adequate numerical device to solve it. This adequacy can be specified mainly in terms of complexity and accuracy.

The differential flatness property of a dynamical system points out, in a reverse way, the causal relation existing between its inputs and its eventually flat outputs.

Since Neural Networks are particularly well adapted to reproduce causal relations, even in the case of very complex systems, it appears of interest to try to build a neural network with this objective. Once correctly trained, the neural network should be an input-output device where the inputs are provided by the tracked trajectory; while the outputs of the neural network are the nominal flight control parameters (see Figure 2).

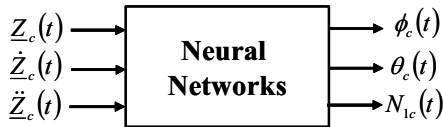

**Figure 2. Reference input generator by Neural-networks**

Multilayer neural networks (MLNN) have been shown to be able to perform general function approximation through the selection of a neural network structure associated to a learning process (Haykin, 1994). The selection of the structure and of a learning algorithm strongly depends on empirical rules while numerous candidate neural networks structures and learning algorithms are available.

In order to achieve an acceptable accuracy and a sufficient generalization capability, a large amount of training data is necessary. Here the training data is composed of sets of trajectories for  $\underline{Z}$  and  $\underline{U}$  which can be provided from either flight test data or even from commercial flight data in which maneuvers are performed manually or by the autopilot engaged in a basic attitude-holding mode so that no guidance loop are active at that time (Mora-Camino, 1993).

Since for modern aircraft onboard navigation systems are able to estimate with good accuracy the current aircraft position, inertial speed and wind speed, their records can be used as a basis for the training of the neural network.

## 6. Validation Results

A simulation model of a light aircraft, the Navion (Schmidt, 1998) with a piston-propeller engine and a basic controller for attitude holding has been used for the generation of training data and for validation purposes.

Preliminary simulation results have been obtained in the case of maneuvers in the vertical plane.

In this study, the conventional Error-Back-Propagation neural network with only one hidden layer has been selected to perform the inversion of flight guidance dynamics, although many other neural network structures (Quiroga Rodriguez, 2005) have been investigated.

Figure 3 displays some of the trajectories which have been considered to generate training data.

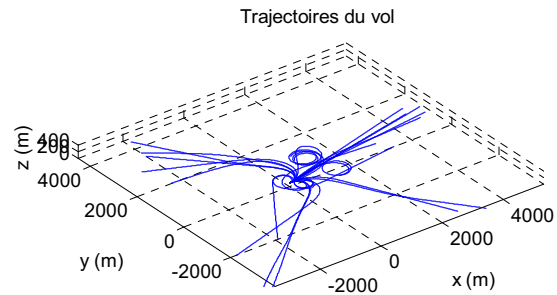

**Figure 3. A set of training trajectories**

The structure of the retained neural network comprises seven inputs nodes, about 30 neurons in the hidden layer with a hyperbolic tangent activation function, and three output nodes with linear transfer functions. The seven inputs are altitude, three components of inertial velocity and three components of inertial acceleration. The three outputs are the pitch  $\theta$ , the roll  $\phi$  and  $\Omega$ , the engine regime.

Figure 4 and figure 5 display examples of training performances for different structures and sizes of the training data base.

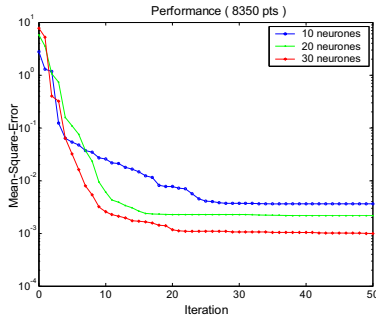

**Figure 4. Training performance with different number of neurons in the hidden layer**

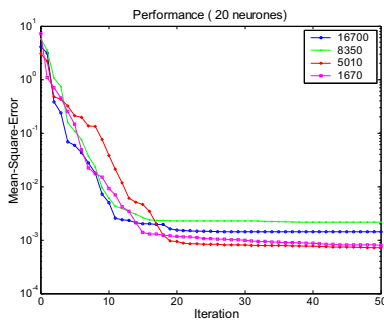

**Figure 5. Training performance for different sizes of the training data base**

Once the weightings of a neural network have been optimized, the training of the neural network must be validated using an independent validation data base. Table 1 displays an example of validation data performances. There  $L(E)$  is the total mean square error of the neural network for a given inter neurons weighting pattern and computed either over training data or validation data.  $S$  is the number of neurons in the hidden layer and  $n$  is the number of effective connections between neurons.

**Table 1. Example of training and validation data**

S	$n$	$L(E)$ training	$L(E)$ Validation
1 5	271	$4,15 \times 10^{-4}$	$3,87 \times 10^{-3}$
1 7	322	$3,99 \times 10^{-4}$	$2,72 \times 10^{-3}$
1 8	349	$3,42 \times 10^{-4}$	$1,20 \times 10^{-3}$
1 9	377	$2,59 \times 10^{-4}$	$1,75 \times 10^{-3}$
2 5	566	$1,85 \times 10^{-4}$	$3,52 \times 10^{-3}$

A relevant validation of the neural network is obtained when in nominal conditions (nominal flight model, no wind variation), the outputs of the neural networks are submitted as reference values to an autopilot operating in basic modes (attitude angles and engine regime tracking). Figure 6 displays the corresponding simulation structure while figures 7 and 8 show the resulting reference and response trajectories of the simulated aircraft.

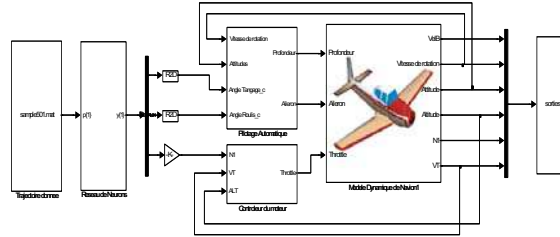

**Figure 6. Open loop flight simulation structure**

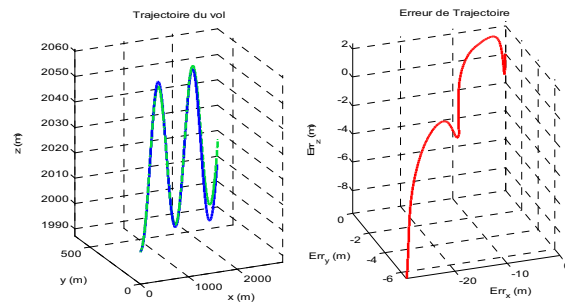

**Figure 7. Example of open loop performance for flight trajectories**

It happens that the resulting control structure is open loop and to react appropriately to the effect of external perturbations as well as to the drift caused by modeling errors, a closed loop must be introduced in the control structure so that robustness is achieved. In (Lu et al, 2006), this issue is tackled, showing that the neural inversion guidance dynamics provides a sound basis to design an efficient 4D trajectory tracking systems for aircraft.

## 7. Conclusion

This paper has shown how neural networks can be used to take profit of the implicit differential flatness property of aircraft flight guidance dynamics.

Differential flatness is a characteristic shared by many non linear systems and in the case of complex systems, this property may appear in an implicit way. In this study, to make this property valuable for real time trajectory tracking, a feed-forward neural networks structure has been proposed to invert the flight guidance dynamics.

The performed numerical experiments show that, adopting classical neural networks structures and learning schemes, it is possible to achieve this objective.

This approach allows an adequate identification of the inverse input-output relations associated to the flatness property of flight guidance dynamics. This results in a useful numerical tool for new trajectory tracking applications.

However many questions such as the definition of a minimum set of trajectories generating adequate training data, the search for more efficient dynamics inversion neural network structures, the setting of a clear balance between the neural inversion accuracy and the amount of feedback control effects, and the generation of efficient reference trajectories, remain open for further research work. Note, considering this last question, that neural networks can also contribute significantly to the definition of optimal reference trajectories (Mora-Camino et al, 2000).

## 8. References

- [1] M. Fliess, J. Lévine, P. Martin and P. Rouchon, "Flatness and defect of non-linear systems: theory and examples". *Int. J. Control*, Vol. 61, No. 6, pp. 1327-1361, 1995.
- [2] L. Lavigne, F. Cazaurang and B. Bergeon, "Modeling of Longitudinal Disturbed Aircraft Model by Flatness Approach", in *AIAA Guidance, Navigation, and Control Conference and Exhibit*, Texas Austin, USA, 2003.
- [3] P. Martin, "Contribution à l'étude des systèmes différentiels plats", Ph.D. Dissertation, Ecole des Mines de Paris, France, 1992.
- [4] B.L. Steven and F. L. Lewis, "Aircraft Control and Simulation" John Wiley & Sons, Inc., 1992.
- [5] W. C. Lu, F. Mora-Camino, M. de Coligny and K. Achaibou, "Flight Mechanics and Differential Flatness" in *DINCON 2004*, Ilha Solteira, Brazil, pp. 830-839, 2004.
- [6] S. Haskin, "Neural Networks, a Comprehensive Foundation", Macmillan Publishing Company, N.J., 1994.
- [7] F. Mora-Camino, "Avionique", Lecture Notes, ENAC, 1993.
- [8] L.V. Schmidt, "Introduction to Aircraft Flight Dynamics", AIAA Education Series, 1998.
- [9] C.E. Quiroga Rodríguez, "Représentation Neuronale de la Dynamique de Vol d'un Aéronef", MSc/DEA report, LAAS du CNRS, July 2005.
- [10] W.C. Lu, L. Duan, F. Mora-Camino and K. Achaibou, "Design of a generic flight guidance system based on differential flatness and neural networks", *SICPRO06 conference*, Moskow, 2006.
- [11] F. Mora-Camino, T. Miquel, K. Achaibou, R. M. Faye, S. Sawadogo and B. Ouattara, "Minimum time trajectory generation for relative guidance of aircraft with neural networks" in *Inverse Problems, Design and Optimization Symposium*, Rio de Janeiro, Brazil, 2004.