

Performance of GPS receivers with more than one multipath

Christophe Macabiau, Benoit Roturier, Abdelahad Benhallam, Eric Chatre

► **To cite this version:**

Christophe Macabiau, Benoit Roturier, Abdelahad Benhallam, Eric Chatre. Performance of GPS receivers with more than one multipath. ION GPS 1999, 12th International Technical Meeting of the Satellite Division of The Institute of Navigation, Sep 1999, Nashville, United States. pp 281 - 288, 1999. <hal-01021687>

HAL Id: hal-01021687

<https://hal-enac.archives-ouvertes.fr/hal-01021687>

Submitted on 31 Oct 2014

HAL is a multi-disciplinary open access archive for the deposit and dissemination of scientific research documents, whether they are published or not. The documents may come from teaching and research institutions in France or abroad, or from public or private research centers.

L'archive ouverte pluridisciplinaire **HAL**, est destinée au dépôt et à la diffusion de documents scientifiques de niveau recherche, publiés ou non, émanant des établissements d'enseignement et de recherche français ou étrangers, des laboratoires publics ou privés.

PERFORMANCE OF GPS RECEIVERS WITH MORE THAN ONE MULTIPATH

Christophe MACABIAU, Benoît ROTURIER, Abdelahad BENHALLAM
CNS Research Laboratory of the ENAC
Eric CHATRE
STNA

BIOGRAPHY

Christophe Macabiau is a Post-Doctoral researcher at the Ecole Nationale de l'Aviation Civile (ENAC) in Toulouse, France. After working in 1993 for the MLS Project Office in Ottawa, Canada, he received his Ph.D. from the Laboratoire de Traitement du Signal et des Télécommunications of the ENAC in 1997. He is currently working on the application of code and phase LADGPS positioning techniques to aeronautics.

Benoît Roturier graduated as an electronics engineer in 1985 from the Ecole Nationale de l'Aviation Civile (ENAC), Toulouse, France. After working for 18 months at Tahiti Faaa airport, French Polynesia, he led the Instrument Landing Team at the Service Technique de la Navigation Aérienne (STNA) in Paris from 1987 to 1989. Since 1990, he has been teaching and doing research at the ENAC, where he is currently in charge of the CNS Research Laboratory. He obtained his Ph.D. in 1995 from the Institut National Polytechnique de Toulouse (INPT). His current research area is propagation modeling for aeronautical telecommunication systems.

Abdelahad Benhallam obtained his Ph.D. in communications from the Institut National Polytechnique de Toulouse in 1988. His areas of research include satellite communications, radionavigation and nonstationary signal processing. He is in charge of the signal processing department of the CNS Research Laboratory of the Ecole Nationale de l'Aviation Civile (ENAC).

ABSTRACT

A wide majority of studies on the effect of multipath focused on the analysis of the code and phase tracking errors when only two rays enter the tracking loops, namely the direct ray plus one diffracted ray. Unfortunately, this condition does not correspond to the most frequent situations, where the received signal can be the discrete sum of several powerful replicas of the direct signal. The aim of this paper is to present the theoretical results of a study that identifies the performance of the GPS receivers in the case where more than two powerful

rays enter the tracking loops. The theoretical analysis assuming a triangular autocorrelation function with an infinite receiver bandwidth shows that in the case of continuous tracking, if the summed amplitudes of the reflected signals is lower than the amplitude of the direct signal, the code error envelope of the composite signal can be approximated as the sum of the code error envelope for each individual ray, except in its transition zones. The deviation with respect to the linear superposition assumption is negligible in the ideal case of a triangular autocorrelation function with an infinite receiver bandwidth for the narrow correlator DLLs and the DLLs controlled by linear combinations of correlator outputs. As the receiver bandwidth decreases, the non linear effects become more important and the deviation is increased.

I. INTRODUCTION

The tracking performance of the GPS receivers is highly degraded when the received signal is affected by multipath propagation. A large number of studies on the effect of multipath on the code and phase tracking errors were carried out, as summarized in [Braasch, 1996].

Several studies led to the implementation of specific structures designed to reduce the multipath induced errors, like the Narrow Correlator receiver [Fenton et al, 1991], [Van Dierendonck et al, 1992], the Multipath Estimating Delay Lock Loop (MEDLL) [Van Nee, 1994], [Townsend et al., 1995], the Multipath Elimination Technology (MET) [Townsend et al., 1994], Strobe and Edge correlators [Garin et al., 1996], Early1-Early2 Tracker [Mattos, 1996], Multipath Mitigator Types A and B [Hatch et al., 1997], Compensated Correlators [Doris, 1997], Enhanced Strobe correlator [Garin et al., 1997] and Gated and High Resolution Correlators (HRC) [McGraw et al., 1999].

The performance of the proposed techniques is publicly advertised by plotting the code and phase tracking error envelopes as a function of the relative delay of the reflected signal with respect to the direct signal. Therefore, the end user may only know the maximum magnitude of the synchronization errors when only two rays enter the

tracking loops, namely the direct ray plus one diffracted ray.

Unfortunately, this condition does not correspond to the most frequent situations, where the received signal can be the discrete sum of several powerful replicas of the direct signal. For example, the antenna can be hit by the Right Hand Circular Polarization (RHCP) line-of-sight signal coming from the satellite, the Left Hand CP (LHCP) signal reflected off the ground, and several RHCP signals scattered by a set of buildings and the ground.

Figure 1 shows an example of combination of multipath signals engendered by the ground and a building wall.

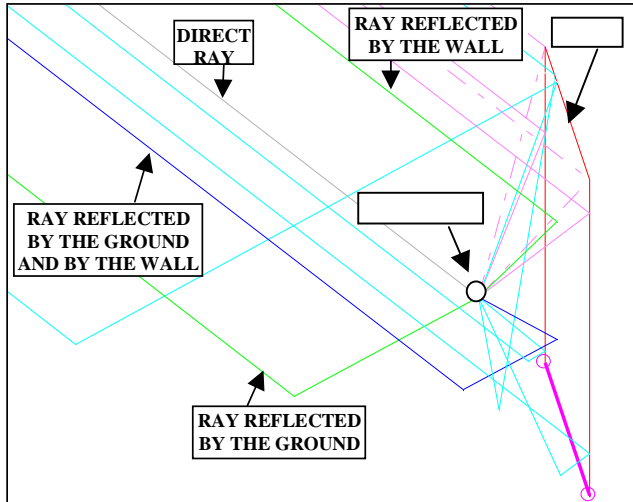

Figure 1: Combination of reflected and diffracted signals sensed by the receiving antenna

This paper presents the main theoretical results of a study that aims at determining the performance of the GPS receivers when the signal is affected by several multipath. It is often thought that the effect of several multipath may be extrapolated from the two-ray envelope error curve by a linear superposition. However, the discriminators used in practice are non linear in nature, hence it is not clear if this linear superposition is really valid.

Here, we first present the theoretical analysis that was performed, and some resulting tracking error envelopes obtained through analytical determination and by simulation. Finally, we discuss the validity of the linear superposition above mentioned.

II. MEASUREMENT MODELS

The C/A signal entering the tracking loops is the RF signal sensed by the antenna, fed to the RF unit where it is filtered, amplified, down-converted to intermediate frequency, sampled and quantized. The incoming composite C/A signal for one single satellite is modeled as follows:

$$V(k) = \sum_{i=0}^N A_i(k) D(kT_s - \tau_i(k)) C_f(kT_s - \tau_i(k)) \times \cos(2\pi f_0 kT_s - \theta_i(k)) + n_f(k) \quad (1)$$

where

- k is the discrete time index and T_s is the internal sampling period of the receiver.
- f_0 is the intermediate frequency of the receiver.
- $N+1$ is the total number of replicas entering the loops. The line-of-sight signal is denoted with subscript 0.
- A_i is the amplitude of each replica, and D is the P/NRZ/L navigation message.
- C_f is the C/A code as filtered by the RF unit, and n_f is the filtered additive noise.
- τ_i and θ_i are respectively the total group and phase propagation delays of each ray.

The operations performed by the tracking loops called the Phase Lock Loop (PLL) and the Delay Lock Loop (DLL) are illustrated in figure 2 for a classical receiver. The aim of these tracking loops is to generate local replicas of the code and carrier that are synchronized with the line-of-sight signal. To achieve these objectives, the loops control local oscillators whose outputs are continuously compared with the incoming signal.

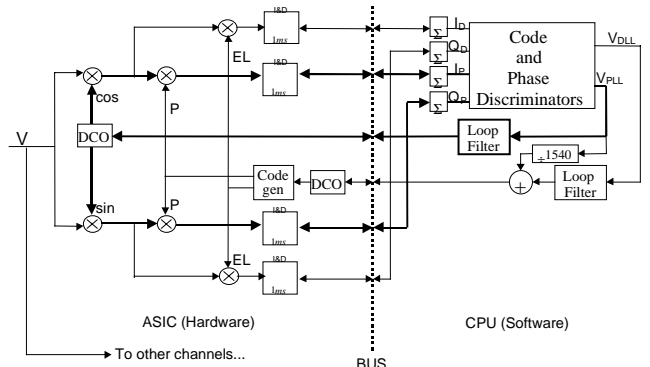

Figure 2: Architecture of a digital GPS receiver (courtesy SEXTANT AVIONIQUE).

The input signal V is first down-converted into the I and Q channels by mixing it with the in-phase and quadrature outputs of the PLL local oscillator. Then, these two signals are multiplied by a punctual replica of the tracked C/A code, and M samples of the resulting signals are cumulated by the Integrate and Dump (I&D) filters to form the I_P and Q_P data that are later used to control the PLL and the DLL. In parallel, the initial I and Q channels are multiplied by a reference waveform denoted EL composed of a linear combination of code replicas with specific delays. This product provides a combination of various correlation values called I_{DEL} and Q_{DEL} after integration by the I&D filters that are used to drive the DLL.

The I_P, Q_P, I_{DEL} and Q_{DEL} samples are then combined in a non linear fashion to form the PLL and DLL discrimination tensions V_{PLL} and V_{DLL} . These

discrimination functions are finally filtered and fed to the PLL and DLL local oscillators.

For example, the discrimination function of the classical dot-product DLL is proportional to:

$$V_{DLL}(k) = \frac{I_{D_{EL}} I_P + Q_{D_{EL}} Q_P}{I_P^2 + Q_P^2} \quad (2)$$

where

$$\left\{ \begin{array}{l} I_{D_{EL}}(k) = \sum_{m=0}^{M-1} V(k-m) \cos(2\pi f_0(k-m)T_s - \hat{\theta}(k)) \times \\ \quad EL((k-m)T_s - \hat{\tau}(k)) \\ Q_{D_{EL}}(k) = \sum_{m=0}^{M-1} V(k-m) \sin(2\pi f_0(k-m)T_s - \hat{\theta}(k)) \times \\ \quad EL((k-m)T_s - \hat{\tau}(k)) \end{array} \right. \quad (3)$$

and

$$\left\{ \begin{array}{l} I_P(k) = \sum_{m=0}^{M-1} V(k-m) \cos(2\pi f_0(k-m)T_s - \hat{\theta}(k)) \times \\ \quad C((k-m)T_s - \hat{\tau}(k)) \\ Q_P(k) = \sum_{m=0}^{M-1} V(k-m) \sin(2\pi f_0(k-m)T_s - \hat{\theta}(k)) \times \\ \quad C((k-m)T_s - \hat{\tau}(k)) \end{array} \right. \quad (4)$$

In these expressions, $\hat{\tau}$ and $\hat{\theta}$ are the code and carrier phase delay estimates that are applied to the local oscillators.

The reference signal $EL(k)$ can have various expressions, among which are:

- $EL(k) = C(kT_s - \hat{\tau} - \frac{\Delta}{2}) - C(kT_s - \hat{\tau} + \frac{\Delta}{2})$ (5)

for the Early minus Late DLL, where Δ is the Early-Late chip spacing

- $EL(k) = C(kT_s - \hat{\tau} - \frac{\Delta}{2}) - C(kT_s - \hat{\tau} + \frac{\Delta}{2}) - 2[C(kT_s - \hat{\tau} - \frac{\Delta}{4}) - C(kT_s - \hat{\tau} + \frac{\Delta}{4})]$ (6)

for a DLL controlled by a linear combination of correlator outputs, such as the HRC, the MET, etc...

It can be shown that the discrimination function has the expression given in (7) when the reference signal $EL(k)$ is a simple Early minus Late function as in (5), and when the incoming signal is the signal modeled as in (1):

$$V_{DLL}(k, \Delta) = \sum_{i=0}^N \sum_{j=0}^N A_i A_j D(kT_s - \tau_i) D(kT_s - \tau_j) R(\varepsilon_{D_j}) \times \quad (7)$$

$$[R(\varepsilon_{D_0} + \Delta \tau_i - \frac{\Delta}{2}) - R(\varepsilon_{D_0} + \Delta \tau_i + \frac{\Delta}{2})] \cos(\theta_i - \theta_j) + n_{DLL}(k)$$

where

- $\varepsilon_{D_i} = \tau_i - \hat{\tau}$ is the deviation between the group delay of ray i and the code delay estimate.
- Δ is the early-late chip spacing.

- R is the cross-correlation function of the incoming filtered code and the locally generated code, as presented in (8):

$$R(\varepsilon) = \sum_{m=0}^{M-1} C((k-m)T_s - \hat{\tau}) C_f((k-m)T_s - \tau) \quad (8)$$

- n_{DLL} is the contribution of the noise to the discrimination function.

In the case of a DLL controlled by a linear combination of several correlator outputs such as (6), as can be found in the Strobe correlator, the MET, or the HRC, the discrimination function is:

$$V_{DLL}(k) = V_{DLL}(k, \Delta) - 2V_{DLL}(k, \frac{\Delta}{2}) \quad (8)$$

The code and phase tracking errors, ε_{D_0} and ε_{P_0} , are the deviations between the true group and phase propagation delays of the direct signal, τ_0 and θ_0 , and their corresponding estimates $\hat{\tau}$ and $\hat{\theta}$.

III. METHODOLOGY

The tracking errors were determined using theoretical analysis, complete receiver simulation, and measurements using a signal generator. We only present here the results of the theoretical analysis and the simulation results for the two receiver structures controlled by the reference waveforms presented in (5) and (6). The characteristics of the tracking error due to noise were not analyzed, therefore all the results presented here assume noise is negligible.

The theoretical expressions of the tracking errors were obtained by determining the code and phase tracking errors ε_{D_0} and ε_{P_0} such that the DLL and PLL discrimination functions are canceled. This was done assuming that the cross-correlation function R is an ideal triangular function.

Then, we ran simulations to determine the zero-crossing points of the discrimination functions in the case of a band-limited receiver for actual C/A codes.

IV. THEORETICAL CODE TRACKING ERRORS

If several replicas of the direct signal enter the tracking loops, the quality of the code and phase tracking operations can be severely degraded, and in some cases of destructive collaboration between all the multipath, the loops may even lose lock for some instants.

For a classical Early minus Late DLL including narrow correlator DLLs, if the receiver maintains continuous tracking, if the direct signal is never blocked, and if the sum of the amplitudes of each reflected signal inside the DLL is lower than the amplitude of the direct signal, then the code tracking error is bounded by half the Early minus Late chip spacing. This result is explained by the fact that the Early minus Late loop is not sensitive to

any deformation of the correlation peak outside of its exploration interval.

If the sum of the amplitudes of each reflected signal is larger than the amplitude of the direct signal, then the code tracking error may be much larger than half the Early minus Late chip spacing, as the multipath signals may cooperate to build a correlation peak far away from the direct signal correlation peak. As this case is rarely encountered, it is not analyzed in detail in this paper and it will be presented later.

It results from the theoretical analysis that the extreme values of the code tracking errors are obtained in two distinct cases:

- when the direct signal and all the reflected signals are in phase
- when each of the reflected signals is out of phase with respect to the direct signal.

One of the consequences of this result is that it is less probable that the multipath signals cooperate to arrange perfectly in phase or out of phase with respect to the line-of-sight signal than in the single reflection case. Therefore, it is less probable that a receiver hit by several replicas of the line-of-sight signal reaches the envelopes of the tracking errors than a receiver hit by only one reflected ray.

For short delays and powerful multipath, the absolute maximum magnitude of the phase tracking error is the product of $\lambda/4$ by the number of rays entering the PLL, as illustrated in figure 3.

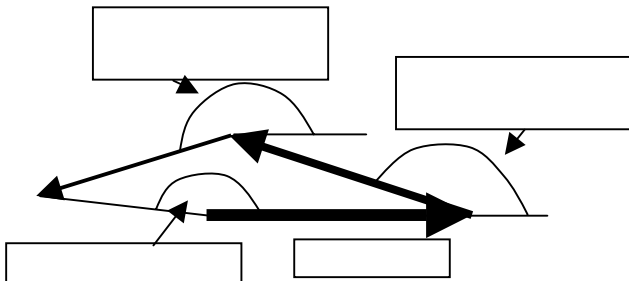

Figure 3: Phasor diagram showing that for extreme configurations, the absolute maximum phase tracking error is the product of $\lambda/4$ by the number of rays.

However, the phase tracking error envelopes depend on the combined PLL and DLL performance, and we only focus here on the code tracking error envelopes.

Figure 4 shows the envelope of the code tracking error for a $0.1 T_c$ narrow correlator, in the case where the signal is the sum of the line-of-sight signal plus two reflected signals. This figure was plotted using theoretical expressions obtained using (5), assuming the C/A code autocorrelation function is an ideal triangle function, and assuming the pre-correlation bandwidth is infinite. As we can see in this figure, the shape of the code tracking error envelope can be divided in four main regions. The first region corresponds to the case where both rays combine to induce non-zero tracking errors, and the resulting envelope is the box visible in the foreground. Its height is the sum of the maximum tracking errors induced by each ray. The second region is the domain where both rays have a relative delay larger than $T_c + \Delta/2$, therefore not influencing the DLL any more. The third and fourth regions are the regions where one of the ray has gone out of the area of influence of the DLL, and only remains the tracking error due to the closest ray.

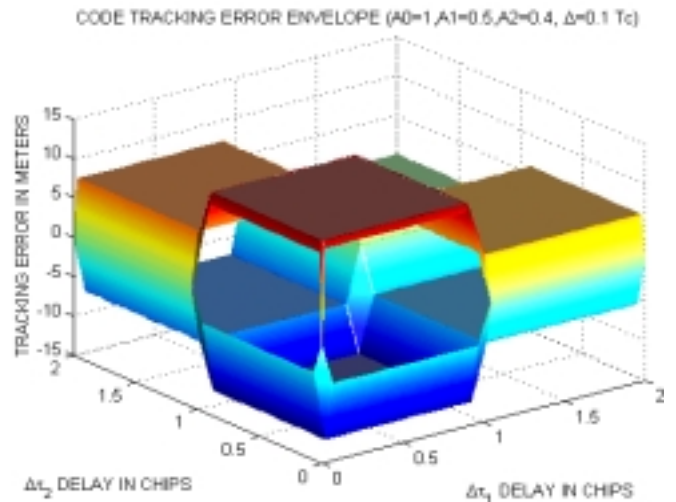

Figure 4: Code tracking error envelope for 2 reflected rays with a total amplitude $< LOS$ amplitude ($0.1 T_c$ narrow correlator DLL).

Figure 5 shows the envelope of the code tracking error for a $0.1 T_c - 0.05 T_c$ linear combination DLL obtained using (6), in the same case as previously. As this type of loop is solely influenced by multipath having short and chip range delays, only three small non-zero regions exist. The first non-zero region corresponds to the case where at least one of the rays has a short delay. In that case, the maximum tracking error is approximately the sum of the maximum tracking error induced by each ray. The second and third non-zero regions are the regions where at least one of the rays has a delay close to one chip, and the maximum tracking error of each individual ray can be summed, except if one of the rays has a short delay.

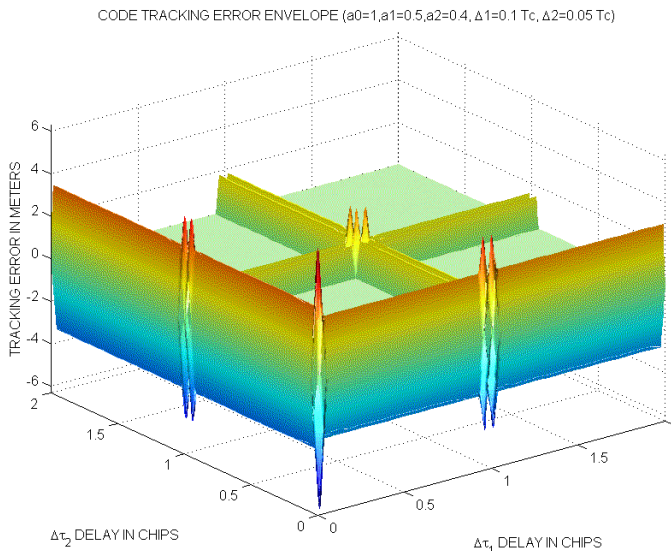

Figure 5: Code tracking error envelope for 2 reflected rays with a total amplitude < LOS amplitude ($0.1 T_c - 0.05 T_c$ DLL).

As introduced previously, in most of the situations, these envelopes coincide with the sum of the single envelopes obtained for each individual ray, except in their transition zones.

For a narrow correlator receiver, this happens when the relative delays are close to 0 or 1 chip, as we can see in the diagonal cross section presented in figure 6.

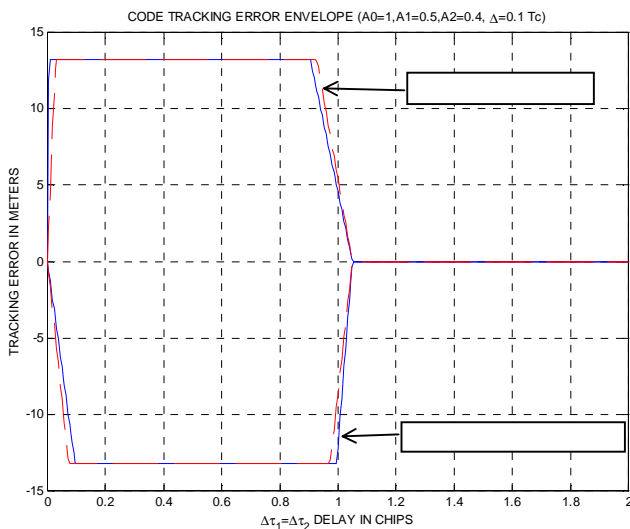

Figure 6: Comparison of the true envelope and the envelope obtained using the linear approximation assumption for a $0.1 T_c$ narrow correlator (diagonal cross-section).

For a standard 1 chip spacing correlator, the deviation with respect to the linear addition assumption is significant, as we can see in figure 7.

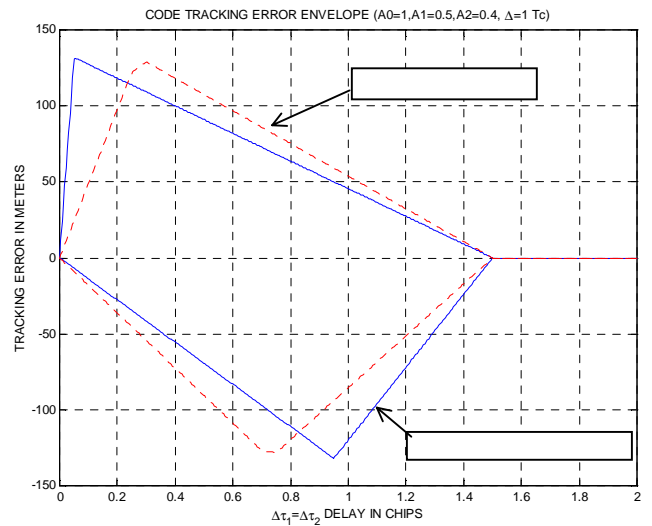

Figure 7: Comparison of the true envelope and the envelope obtained using the linear approximation assumption for a $0.1 T_c$ standard correlator (diagonal cross-section).

For a DLL controlled by a reference signal that is a linear combination of two Early-Late signals, the deviation between the true theoretical 3D function and the linear approximation is less severe, as illustrated in figures 8 and 9.

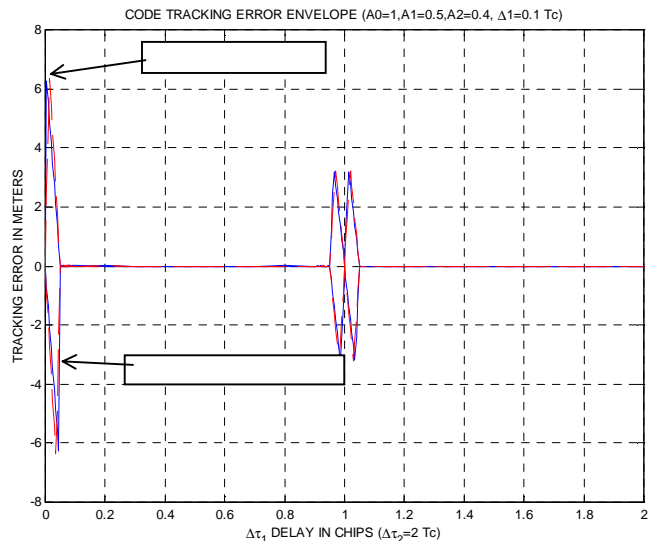

Figure 8: Comparison of the true envelope and the envelope obtained using the linear approximation assumption for a $0.1 T_c - 0.05 T_c$ DLL (diagonal cross-section).

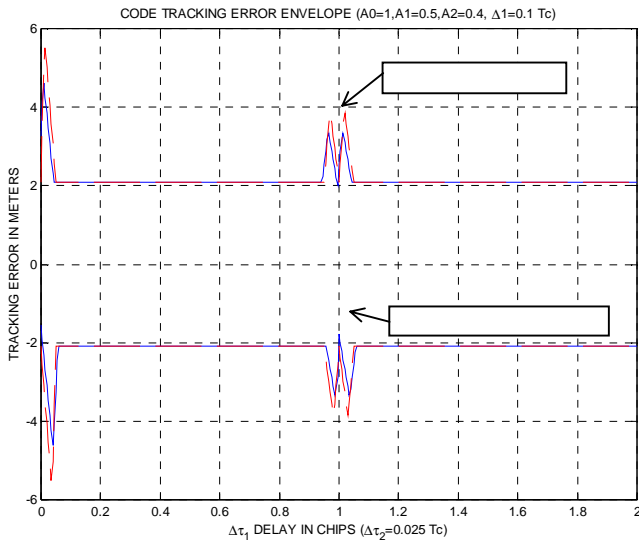

Figure 9: Comparison of the true envelope and the envelope obtained using the linear approximation assumption for a $0.1 T_c$ - $0.05T_c$ DLL (perpendicular cross-section).

V. BAND-LIMITED CASE

In order to determine the influence of actual shape of the cross-correlation function of the C/A codes, we ran simulations to determine the tracking errors in the case where the incoming codes are actual C/A codes filtered by the RF front-end pre-correlation filter. We chose a large bandwidth of 16 MHz well suited when manipulating narrow correlation differences.

Figure 10 shows the envelope of the code tracking error for a $0.1 T_c$ narrow correlator, in the case where the signal is the sum of the line-of-sight signal plus two reflected signals. By comparing figures 10 and 4, we see that the influence of the band-limited actual C/A codes on the envelope is simply to smooth the curves and maintain a small non-zero tracking error past the influence of each ray due to the autocorrelation sidelobes.

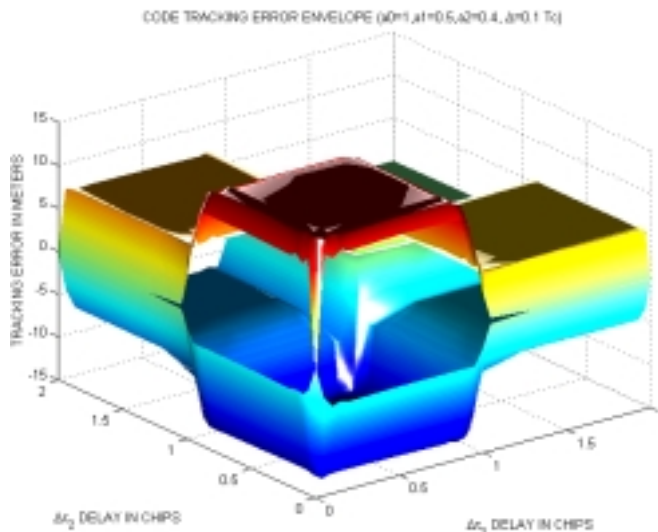

Figure 10: Code tracking error envelope for 2 reflected rays with a total amplitude $< LOS$ amplitude ($0.1 T_c$ narrow correlator DLL with a 16 MHz bandwidth)

Figure 11 shows a diagonal cross-section of figure 10 (solid curve) compared to the envelope obtained with the linear superposition assumption (dashed curve). As we can see, the error between both curves reaches two meters for that case.

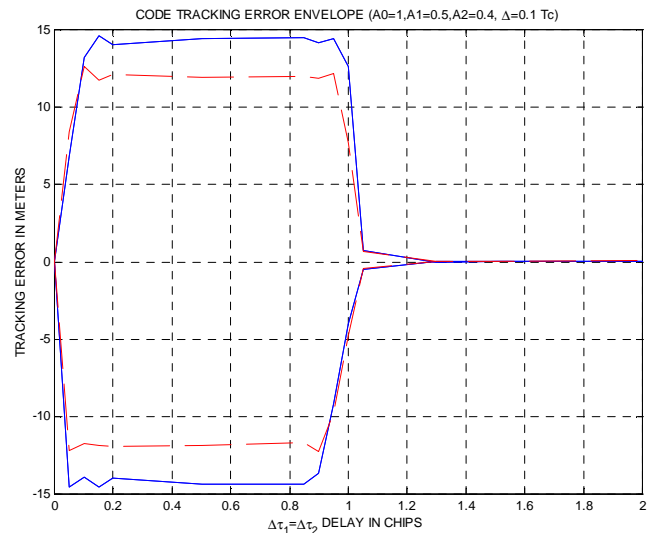

Figure 11: Comparison of the true envelope and the envelope obtained using the linear approximation assumption for a $0.1 T_c$ narrow correlator with a band-limited actual C/A code (diagonal cross-section).

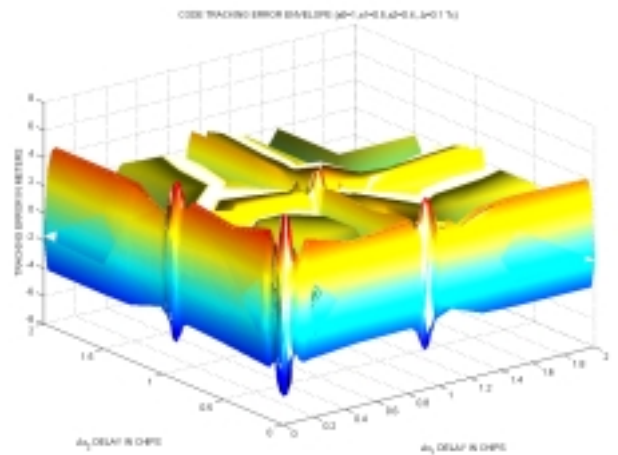

Figure 7: Comparison of the true envelope and the envelope obtained using the linear approximation assumption for a $0.1 T_c$ - $0.05T_c$ DLL (diagonal cross-section).

VI. CONCLUSION

This paper shows the theoretical results of an analysis that aims at determining the performance of GPS receivers tracking a signal degraded by more than one multipath. The results presented here focused on the code tracking error envelopes when the sum of the amplitudes of the reflected signal is lower than the amplitude of the line-of-sight signal.

We show that when the incoming signal is composed of the direct signal and several replicas of this signal, assuming a triangular autocorrelation function with an infinite receiver bandwidth, the code tracking error envelope can be approximated as the sum of the code tracking error envelopes expected for each individual ray, except in the transition zones of these envelopes.

In these transition zones for the ideal autocorrelation function, the deviation is small as a first approximation in the case of a narrow correlator receiver, but the approximation error is highly degraded when the correlator spacing is widened.

In the case of a DLL controlled by a linear combination of correlation values, the approximation error in the transition zones is also small in the ideal case, if the chip spacings used are narrow.

As the receiver bandwidth decreases, the non linear effects become more important and the deviation with respect to the linear superposition assumption is increased.

The next results to be presented are the phase tracking error envelopes for these receiver structures, and the code and phase tracking errors for other structures. In addition, we will present the characteristics of the code tracking error when the sum of the amplitudes of the reflected signals is larger than the amplitude of the direct signal, and the measured code and phase tracking error envelopes using a signal generator.

ACKNOWLEDGMENTS

The authors wish to thank the STNA for supporting this research, and SEXTANT AVIONIQUE for having provided technical assistance. In addition, Redouane Yazid deserves our thanks for helping us performing this study.

REFERENCES

Braasch M. (1996) « *Global Positioning System: Theory and Applications* », volume 1, chapter 'Multipath Effects', pages 547-568, AIAA.

Doris D. (1997) « *Modélisation de récepteurs GPS. Application à l'étude de l'influence des multitrajets sur les performances du récepteur L1 GPS* », Thèse INPT, Septembre.

Fenton P., Falkenberg B., Ford T., Ng K. and Van Dierendonck A.J. (1991) « *NovAtel's GPS Receiver – the High Performance OEM Sensor of the Future* », proceedings of ION GPS-91, Albuquerque, Sept 9-13.

Garin L., Van Diggelen F. and Rousseau J.M. (1996) « *Strobe and Edge Correlator Multipath Mitigation for Code* », proceedings of ION GPS-96, Kansas City, September 17-20.

Garin L. and Rousseau J.M. (1996) « *Enhanced Strobe Correlator Multipath Rejection for Code and Carrier* », proceedings of ION GPS-97, Kansas City, September 16-19.

Hatch R., Keegan R. and Stansell T. (1997) « *Leica's Code and Phase Multipath Mitigation Techniques* », proceedings of ION National Technical Meeting, Santa Monica, January 14-16.

Mattos P. (1996) « *Multipath Elimination for the Low-Cost Consumer GPS* », proceedings of ION GPS-96, Kansas City, September 17-20.

McGraw G. and Braasch M. (1999) « *GNSS Multipath Mitigation Using Gated and High Resolution Correlator Concepts* », proceedings of ION National Technical Meeting, San Diego, January 25-27.

Townsend B. and Fenton P. (1994) « *A Practical Approach to the Reduction of Pseudorange Multipath Errors in a L1 GPS Receiver* », proceedings of ION GPS-94, Salt Lake City, September 20-23.

Townsend B., Van Nee R., Fenton P. and Van Dierendonck K. (1995) « *Performance Evaluation of the Multipath Estimating Delay Lock Loop* », proceedings of ION National Technical Meeting, Anaheim, January 18-20.

Van Dierendonck A.J., Fenton P. and Ford T. (1992) « *Theory and Performance of Narrow Correlator Spacing in a GPS Receiver* », proceedings of ION National Technical Meeting, San Diego, January 27-29.

Van Nee R., Sierveld J., Fenton P. and Townsend B. (1994) « *The Multipath Estimating Delay Lock Loop : Approaching Theoretical Limits* », proceedings of IEEE PLANS 94, Las Vegas, April 11-15.