



**HAL**  
open science

# Results of the implementation of the fast adaptive bandwidth lock loops on a real GPS receiver in a high dynamics context

Fabrice Legrand, Christophe Macabiau

► **To cite this version:**

Fabrice Legrand, Christophe Macabiau. Results of the implementation of the fast adaptive bandwidth lock loops on a real GPS receiver in a high dynamics context. GNSS 2001, International Conference on Global Navigation Satellite System, May 2001, Seville, Spain. hal-01021702

**HAL Id: hal-01021702**

**<https://hal-enac.archives-ouvertes.fr/hal-01021702>**

Submitted on 30 Oct 2014

**HAL** is a multi-disciplinary open access archive for the deposit and dissemination of scientific research documents, whether they are published or not. The documents may come from teaching and research institutions in France or abroad, or from public or private research centers.

L'archive ouverte pluridisciplinaire **HAL**, est destinée au dépôt et à la diffusion de documents scientifiques de niveau recherche, publiés ou non, émanant des établissements d'enseignement et de recherche français ou étrangers, des laboratoires publics ou privés.

# Results of the implementation of the Fast Adaptive Bandwidth Lock Loops on a real GPS receiver in a high dynamics context

Fabrice Legrand, *CNS Research Laboratory of the ENAC, France.*  
(legrand@recherche.enac.fr)

Christophe Macabiau, *CNS Research Laboratory of the ENAC, France.*  
(macabiau@recherche.enac.fr)

## BIOGRAPHIES

Fabrice Legrand is a Ph.D. student at the ENAC, in the CNS Research Laboratory. His thesis is supported by CNES and Alcatel Space Industries, and dedicated to radio navigation raw measurement integrity and accuracy improvements.

Christophe Macabiau is the head of Signal Processing Laboratory of the CNS Research Laboratory of the ENAC.

## ABSTRACT

The Fast Adaptive Bandwidth (FAB) algorithm is a new method that is able to compute in real-time the optimal setting of the loop filters of a GPS receiver in order to minimize the thermal noise on the code or carrier phase measurements. The optimal setting is computed by taking into account of the imposed line of sight dynamics and of the signal to noise ratio of the incoming signals.

We will present in this paper any results of the implementation of the FAB algorithm on the carrier tracking loops of a real Gec-Plessey GPS receiver. A high dynamics spacecraft flight scenario has been tested by simulating GPS signals with the GSS 2760 GPS signal simulator. An analysis of the results on the improvement of carrier phase measurement accuracy is proposed.

## INTRODUCTION

In radio navigation and localization systems, the technique to compute the position of a user is based on pseudorange measurements between several transmitters and the receiver. The receiver has to synchronize its own local replicas with the incoming signals to extract the navigation data and to perform the measurements. The most popular way to synchronize and to extract information from signals mixed with a carrier and pseudo-random binary sequences (PRN codes) in a noisy transmission channel context, is to use the common Phase and Delay Lock Loops (PLL and DLL) tracking systems.

The most present sources of PLL and DLL synchronization error are the thermal noise, which is proportional to the Equivalent Noise Bandwidth (ENB) and is due to the noise on the transmission channel, and the dynamics stress error, which is conversely proportional to the ENB (see [1]). As these two error sources are conversely proportional, the common method to choose the ENB of the loop is to consider the worst cases of Signal-to-Noise Ratio (SNR) and dynamics of the incoming signal. This results in a sub-optimal use of the loops during periods where dynamics is not maximal. That's why we have proposed in [2] the Fast Adaptive Bandwidth (FAB) algorithm that is able to adapt the ENB of the loops with respect to the real-time dynamics and noise level of the incoming signals. Based on real time estimations of dynamics and SNR of the incoming signal, the FAB algorithm computes the optimal setting of the loop filter coefficients in order to minimize the thermal noise on the code or carrier phase measurements. We have implemented the algorithm on the software of the Gec-Plessey GPS BUILDER receiver, and have made many measurements on signal provided by the GSS 2760 GPS signal simulator.

In this paper, we will present results on the efficiency of the FAB algorithm in the case of a relatively high dynamics application. As the GPS satellite constellation altitude is close to 20000km, dynamics on signals received by users that stand on the earth are often small. To increase dynamics on signals, we have decided to construct a scenario where the distance between the receiver and a GPS transmitter is reduced as possible. This type of situation is realized if we consider the case of a transmission channel between a spaceborne receiver in Low Earth Orbit (LEO) and a pseudolite (for pseudo GPS satellite, which is a ground station that transmitted GPS signals) for the transmitter. In our case, we have simulated a LEO satellite that stands at an altitude of 2000km to obtain a maximal acceleration of 2.5g on the signal when the satellite is exactly above the pseudolite.

The first part of the paper recalls the main properties of the linear model of the loops and describes the FAB algorithm. The second part presents the flight scenario that we have chosen to simulate with the GSS 2760 GPS

signal simulator. The last part shows results of measurements and deals with improvements due to the method.

## THE FAB ALGORITHM

The aim of the FAB algorithm is to compute in real-time the optimal setting of the loop filter in order to minimize the power of the thermal noise on the phase measurements by taking into account of the imposed Line Of Sight (LOS) dynamics of the incoming signal. A schematic representation of the algorithm is shown on figure 1. The

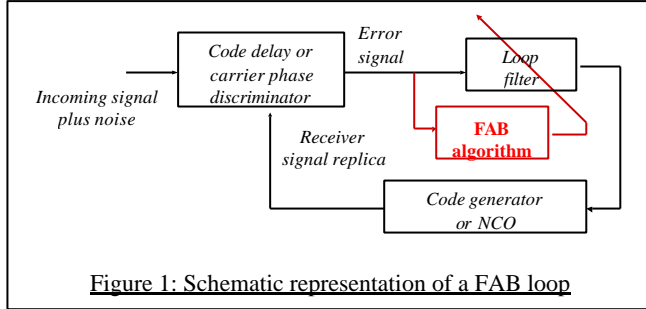

Figure 1: Schematic representation of a FAB loop

two main sources of error of a loop are the thermal noise and the bias due to dynamics on the signal. These two errors are conversely proportional and depend on the length of the Equivalent Noise Bandwidth (ENB) of the loop. The idea of the algorithm is to compute real-time estimations of these two parameters by observing the error signal at the output of the discriminator. The error signal is completely characterized by the transfer function of the loop. Let's consider the useful linear model of a digital PLL that is shown on figure 2 (see [3]). Note that the

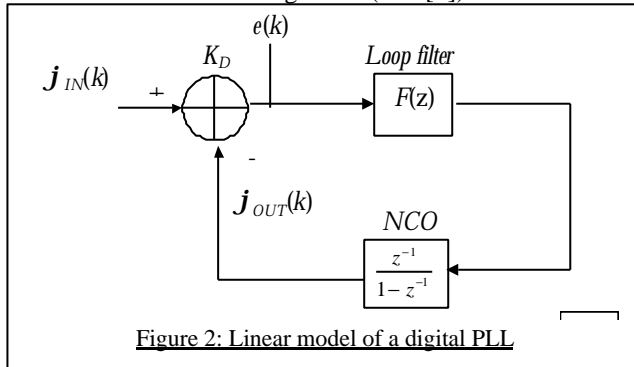

Figure 2: Linear model of a digital PLL

linear model of a DLL (see [1]) is the same as for the PLL where the carrier phase is substituted by the code phase. The local code generator and the local carrier generator are both modeled by a digital integrator. The gain  $K_D$  is the product of the discriminator gain with the Numerically Controlled Oscillator (NCO) gain. The transfer function  $F(z)$  of the loop filter of an  $N^{\text{th}}$  order loop is modeled as

$$F(z) = \frac{\sum_{n=0}^{N-1} b_n \cdot z^{-n}}{(1-z^{-1})^{N-1}} \quad (1)$$

Then we can derive the expression of the transfer function of the error signal from figure 2 as

$$E(z) = \frac{Tz[e(k)]}{Tz[j_{IN}(k)]} = \frac{K_D \cdot (1-z^{-1})}{1 + (K_D \cdot F(z) - 1) \cdot z^{-1}} \quad (2)$$

⇔

$$E(z) = \frac{K_D \cdot (1-z^{-1})^N}{(1-z^{-1})^N + K_D \cdot \sum_{k=0}^{N-1} b_k \cdot z^{-k-1}} \quad (3)$$

Let's note the  $N$  poles of  $E(z)$  as  $\{p_n\}_{n=1..N}$ . Then (3) is equivalent to

$$E(z) = \frac{K_D \cdot (1-z^{-1})^N}{\prod_{n=1}^N (1-p_n \cdot z^{-1})} \quad (4)$$

The relations between the poles of the transfer function and the coefficients of the loop filter are obtained by developing and identifying the denominators of (3) and (4). Then, for an  $N^{\text{th}}$  order loop, these relations are

$$\begin{cases} K_D \cdot b_0 = -\sum_{k=1}^N p_k + N; & K_D \cdot b_1 = \sum_{\substack{k=1 \\ l \neq k}}^N p_k p_l - C_{N-1}^2; \\ K_D \cdot b_2 = -\sum_{\substack{k=1 \\ l \neq k \\ m \neq l}}^N p_k p_l p_m + C_{N-1}^3; \dots; & K_D \cdot b_{N-1} = (-1)^N \cdot \left( \prod_{k=1}^N p_k - 1 \right) \end{cases} \quad (5)$$

where

$$C_n^p = \frac{n!}{p!(n-p)!} \quad (6)$$

Table 1 gives relations for useful orders. For more

Loop filter order	Loop order	Loop filter coefficients
0	1	$K \cdot b_0 = 1 - p_1$
1	2	$K \cdot b_0 = 2 - (p_1 + p_2)$ $K \cdot b_1 = p_1 p_2 - 1$

Table 1: Relations between poles and loop filter coefficients for loops of order 1 and 2

convenience and in the context of the FAB theory, we have chosen to work with a unique pole of order  $N$ . This pole is define as

$$p_k \big|_{k=1..N} = p \quad (7)$$

Then, the stability of the system imposes that

$$|p| < 1 \quad (8)$$

The transfer function of the error signal became equal to

$$E(z, p) = \frac{K_D \cdot (1-z^{-1})^N}{(1-p \cdot z^{-1})^N} \quad (9)$$

Now we can easily predict the level of the noise and the bias on the error signal from equation (9). Suppose that the phase of the baseband input signal is modeled by

$$j_{IN}(t) = \sum_{m=0}^{\infty} j_0^{(m)} \cdot \frac{t^m}{m!} + n(t) \quad (10)$$

where  $j_0^{(m)}$  is the initial value of the  $m^{\text{th}}$  derivative of the input phase and  $n(t)$  is the equivalent Gaussian phase noise. It has been shown on [2] that the sampled and integrated version of (10) over the predetection bandwidth  $Bp$  (usually 50Hz) is equal to

$$j_{IN}(k) = \sum_{m=0}^{\infty} A_0^{(m)} \cdot \frac{k^m}{m!} + n_{IN}(k) \quad (11)$$

where  $A_0^{(m)}$  is the equivalent initial value of the  $m^{\text{th}}$  derivative of the meaning input phase over the predetection interval, and is approximately equal to (see [2])

$$A_0^{(m)} \approx \frac{j_0^{(m)}}{B_p^m} \quad (12)$$

$n_{IN}(k)$  is the equivalent Gaussian phase noise after the predetection filtering. Its variance is equal to

$$\mathbf{s}_{n_{IN}}^2 = \frac{Bp}{2C/N_0} \left( 1 + \frac{Bp}{2C/N_0} \right) \text{ (in } rad^2 \text{)} \quad (13)$$

for the PLL, and to

$$\mathbf{s}_{n_{IN}}^2 \approx \frac{d \cdot Bp}{2C/N_0} \text{ (in squared units of chips)} \quad (14)$$

for the DLL, where  $d$  is the chip spacing between the advanced and delayed arms of the code discriminator. Finally, the variance of the noise on the error signal is equal to

$$\mathbf{s}_{n_{err}}^2 = \mathbf{s}_{n_{IN}}^2 \|E(z, p)\|_2^2 \quad (15)$$

where

$$\|E(z, p)\|_2^2 = \frac{1}{2pj} \oint_{|z|=1} E(z, p) \cdot E(z^{-1}, p) \cdot \frac{dz}{z} \quad (16)$$

The expression of the squared norm of  $E(z)$  as been derived in [2]. Table 2 gives these relations for useful orders of loops in the case of a unique multiple pole of

Loop order	$\ E(z, p)\ _2^2$
1	$\frac{2K_D^2}{p+1}$
2	$\frac{2K_D^2 \cdot (p+3)}{(p+1)^3}$

**Table 2: Squared norm of the observable error transfer function of a lock loop as a function of the multiple pole of the transfer function.**

order  $N$ . The bias on the error signal due to dynamics is given by this particular property of the z-transform (see [4]):

$$E_\infty = \lim_{z \rightarrow 1} \left\{ (z-1) \cdot E(z, p) \cdot TZ \left[ \langle j_{IN}(n) \rangle_k \right] \right\} \quad (17)$$

$\Leftrightarrow$

$$E_\infty = \sum_{m=0}^{\infty} \frac{A_0^{(m)}}{m!} \lim_{z \rightarrow 1} \left\{ (z-1) \cdot E(z, p) \cdot TZ [k^m] \right\} \quad (18)$$

If we derived (18) with the expression of  $E(z)$  for an  $N^{\text{th}}$  order loop given in (9), we find that the terms whose order is smaller than  $N$  are equal to zero (the error converges towards zero), the ones whose order is greater than  $N$  tend towards infinity (the loop diverges), and the term of order  $N$  is a constant. It means that an  $N^{\text{th}}$  loop can track an input phase of order  $N$  with a steady state error of

$$E_\infty = \frac{K_D \cdot A_0^{(N)}}{(1-p)^N} \quad (19)$$

Let's define the Steady State Error Factor (SSEF)  $G$  as the ratio between the steady state error  $E_\infty$  and the equivalent  $N^{\text{th}}$  derivative of the meaning input phase  $A_0^{(N)}$  as

$$G(p) = \frac{E_\infty}{A_0^{(N)}} = \frac{K_D}{(1-p)^N} \quad (20)$$

Finally, if the greater significant dynamics order is  $N$ , then the error signal will be the sum of a bias and a noise. Its expression will be

$$e(k) = G(p) \cdot A_0^{(N)} + n_{err}(k) \quad (21)$$

where  $n_{err}(k)$  is a zero mean Gaussian noise with a variance expressed in equation (15). The values of the dynamics component and of the noise component can be finally estimated by observing the error signal. The dynamics component is equal to the mean value of  $e(k)$  divided by the SSEF, and the variance of the noise component is equal to the variance of  $e(k)$  divided by the squared norm of  $E(z)$ . An easy and low cost method to estimate the mean value  $\mathbf{m}_e(k)$  and the variance  $\mathbf{s}_e^2(k)$  of  $e(k)$  at epoch  $k$  is to use two low-pass filters of order 1 defined by

$$\mathbf{m}_e(k) = (1 - p_{LP}) \cdot e(k) + p_{LP} \cdot \mathbf{m}_e(k-1) \quad (22)$$

and

$$\mathbf{s}_e^2(k) = (1 - p_{LP}) \cdot (e(k) - \mathbf{m}_e(k))^2 + p_{LP} \cdot \mathbf{s}_e^2(k-1) \quad (23)$$

where  $p_{LP}$  sets the time constant and the bandwidth of the low-pass filters. We proposed to adapt the bandwidth of these filters to the bandwidth of the loop in order to have proportional time constants. We have chosen to set the low-pass filter bandwidth at epoch  $k$  as

$$B_{LP}(k) = \frac{1}{2} \frac{ENB(k)}{2ENB(k) + 1} \quad (24)$$

in order to have a power of noise on the estimated bias that is two time lower than the power of noise on the phase measurements. We shown that the relation between  $p_{LP}$  and  $B_{LP}$  is

$$p_{LP} = \frac{1 - 2B_{LP}}{1 + 2B_{LP}} \quad (25)$$

To perform good pseudorange or carrier phase measurements, it is better to minimize the power of the random part of the error. But minimizing the power of the random part of the error results in an increasing of its mean value because the squared norm of  $E(z, p)$  and the ENB are conversely proportional with the SSEF. Moreover, we must be careful that the error signal doesn't leave the lock range of the discriminator. This lock range depends on the discriminator used in the loop. Let's note the lock range of the discriminator as

$$\text{Lock Range} = [-L_{th}, L_{th}] \quad (26)$$

As the error signal is completely characterized by (21), we can compute the better compromise between the SSEF and the squared norm of the error transfer function in order to minimize the ENB, and consequently the thermal noise error on measurements, with the constraint that the error signal stays in the lock range. As the statistic properties of the noise in the error signal and the dynamics component value are known, the optimal condition is

$$|A_0^{(N)}(k).G(p)| + a.\sqrt{\|E(z, p)\|_2^2} \cdot \mathbf{s}_{IN} = L_{th} \quad (27)$$

where the parameter  $a$  sets the probability to be out of the lock range. This probability is given by

$$P_0 = \text{prob}[|e(k)| \geq |E_{\mathbf{y}}(k)| + a.\mathbf{s}_{IN}] \quad (28)$$

⇔

$$P_0 = \int_{|E_{\infty}| + a.\mathbf{s}_b}^{\infty} \frac{1}{\mathbf{s}_b \cdot \sqrt{2p}} \cdot e^{-\frac{(x-|E_{\infty}|)^2}{2\mathbf{s}_b^2}} dx \quad (29)$$

where

$$\mathbf{s}_b = \sqrt{\|E(z, p)\|_2^2} \cdot \mathbf{s}_{IN} \quad (30)$$

and

$$E_{\infty}(k) = A_0^{(N)}(k).G(p) \quad (31)$$

As an example, if we choose  $a$  equal to 1, then the probability  $P_0$  that the error signal is out of the lock range is 0.16, if  $a$  equal 2 then the probability is 0.02, and if  $a$  equal 3 the probability will be 0.001. Finally, the optimal multiple pole of the transfer function that minimizes the power of the thermal noise on the measurements is a solution of the equation

$$f(p) = 0 \quad (32)$$

with

$$f(p) = |A_{IN}(k).G(p)| + a.\sqrt{\|E(z, p)\|_2^2} \cdot \mathbf{s}_{eq} - L_{th} \quad (33)$$

Equation (32) has two solutions. The first is close to  $-1$  and corresponds to a wide ENB, and the second is close to  $1$  and corresponds to a small ENB. Only the second solution is valid for our algorithm. To find the optimal zero of  $f(p)$ , we propose to use the iterative method of Newton-Raphson. An iteration is given by

$$p_{opt}(k+1) = p_{opt}(k) - \frac{f(p_{opt}(k))}{f'(p_{opt}(k))} \quad (34)$$

The use of the absolute value function on the second term of (34) is the condition to converge toward the solution that is close to 1. This method has good properties of convergence and is able to track the optimal solution even if the parameters of dynamics and noise are variable in time. The algorithm is initialize with the pole that corresponds to the highest ENB chosen by the user. This highest ENB is chosen as a function of the highest dynamics that the loop can track. Note that the resulting transfer function of the FAB loop is variable with time because of the variability of its poles. E.I. JURY has shown in [4] that if the poles are not enough slowly variable, then the filter can produce important peak values in the time domain. In the FAB loop, these undesirable peaks could cause the error signal to be out of the lock range. For this reason, it is necessary to smooth the optimal pole of the FAB loop by a low-pass filter before updating the loop filter coefficients. We used a low-pass filter with a minimal time constant of 2 seconds. In the case of quick rise of the dynamics, the time constant of the algorithm doesn't open the effective bandwidth of the loop as fast. As a consequence, a detection system has to be inserted. We propose to watch the difference between two samples of the error signal, and to suddenly open the loop bandwidth and re-initialize the algorithm if this value

is greater than the predicted 4-sigma value of the noise on the error signal. In practical, the lower bound of the loop bandwidth is a function of the level of the phase noise of the NCOs. At low dynamics, the FAB algorithm provides low optimal loop bandwidth that could be under the lower bound if the NCOs are not good. In this case, the loop could not be set at its optimal values. As a conclusion, the different steps in one iteration of the FAB algorithm are: 1) To estimate the variance and the mean values of the observable error signal at the input of the loop filter; 2) To build the optimization function  $f(p)$ ; 3) To find its greater zero in the stability range with the Newton-Raphson method; 4) To smooth the optimal solution not to have undesirable peaks; 5) To update the loop filter coefficients with the appropriate expressions (as it was shown in (5)) as a function of the optimal pole. Finally, the code delay or carrier phase measurement must be corrected by the estimation of the steady state error to cancel the bias due to dynamics.

## DESCRIPTION OF THE SIMULATED SCENARIO

Our objective was to create a high dynamics signal configuration. The highest dynamics situation is obtained in the case of the transmission channel between a pseudolite and a low earth orbit spaceborne receiver. In our case, we have simulated a LEO satellite that stands at a constant altitude of 2000km above the equator (figure 3). The direction of rotation of the satellite is opposite with the one of the Earth. The pseudolite stands at  $0^\circ$  of longitude and latitude. The GSS 2760 GPS signal simulator provides GPS signal. The resulting LOS acceleration is plotted on figure 4.

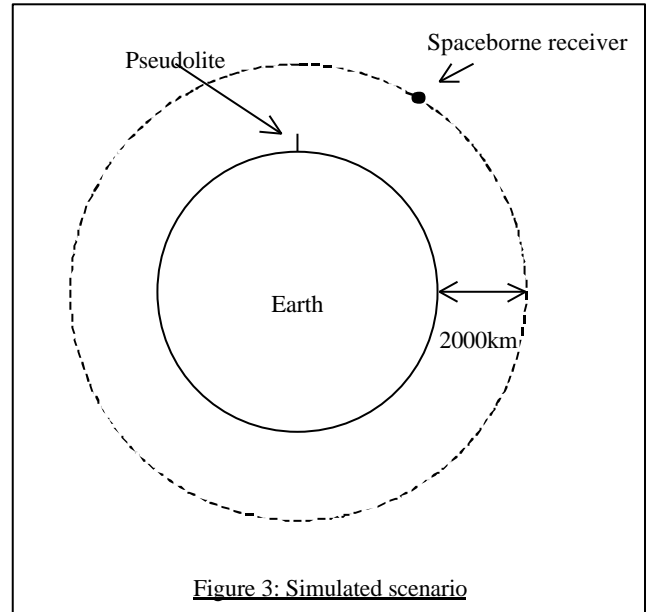

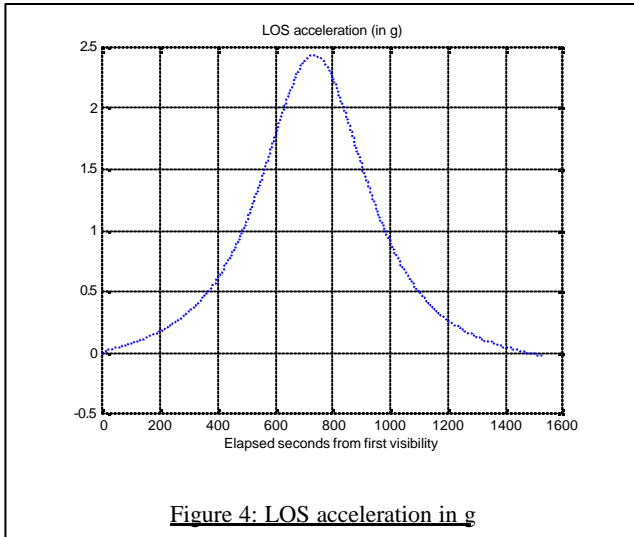

**RESULTS OF MEASUREMENTS**

We use the Gec-Plessey GPS Builder receiver to test our algorithm. The 2.5g maximal LOS acceleration of the scenario is so small to become a problem for the DLL. So we decided to implement our algorithm just in the PLL. There are only Frequency Lock Loops (FLL) in the original source code of GPS Builder, so we had to implement PLL. As the power of the received signal is proportional with the distance between the receiver and the transmitter, the upper bound of C/N0 is obtained when the receiver is just above the pseudolite. Moreover, the LOS acceleration is also maximal at the same instant.

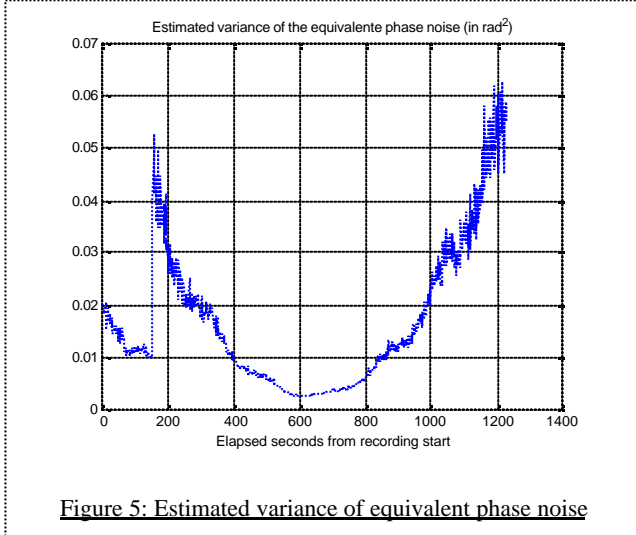

That's the reason why we choose to implement a second order FAB PLL. We know that for second order loops, the bias on the phase measurements is proportional with the LOS acceleration. It means that the noise will be low powered when we need to open the loop bandwidth to track high acceleration and that acceleration will be low when the noise is powerful. This results on a good

compromise between the real-time loop bandwidth and the level of the noise on the received signal.

Let's first see the estimated parameters computed by observing the error signal provided by the phase discriminator. Figure 5 shown the estimated variance of the equivalent phase noise as defined on equation (13). For convenience, we have computed the equivalent C/N0

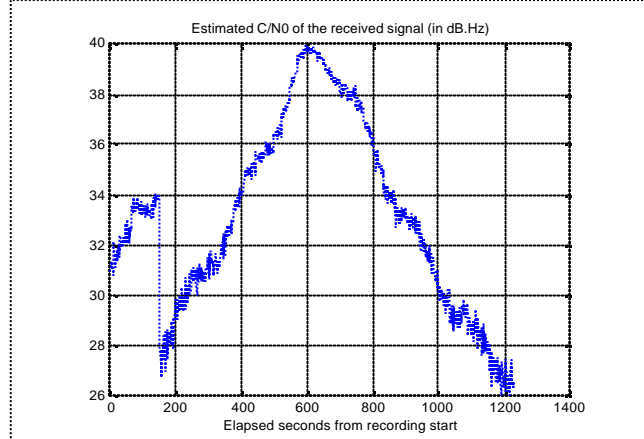

**Figure 6: Estimated C/N0 of the incoming signal**

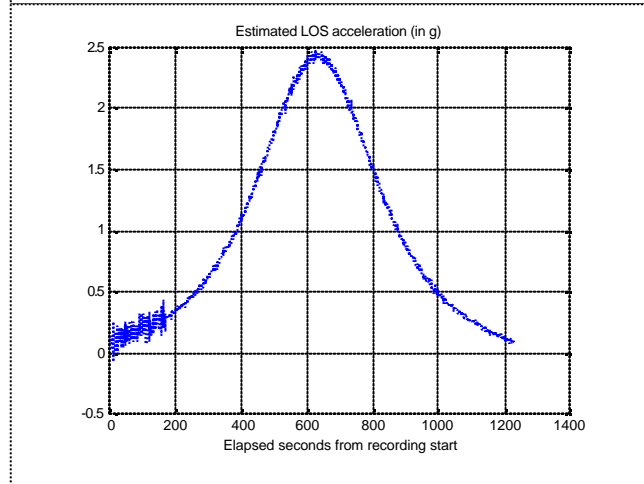

**Figure 7: Estimated LOS acceleration**

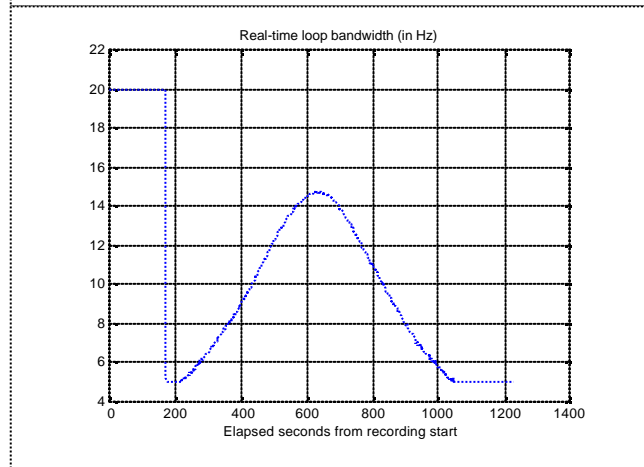

**Figure 8: Real-time FAB loop bandwidth**

from equation (13) as shown on figure 6. The step of

power at the beginning of the curves is due to the fact that we have enhanced the power of the signal to be sure to well acquire the signal. After the acquisition, the power was decreased and the evolution of the C/N0 was only due to the evolution of the range between transmitter and receiver. Figure 7 shows the evolution of the estimated LOS acceleration. Note that estimated LOS acceleration is very close to the real one shown on figure 4.

From the estimated parameters of the signal, the FAB algorithm has adapted the loop bandwidth in real-time as

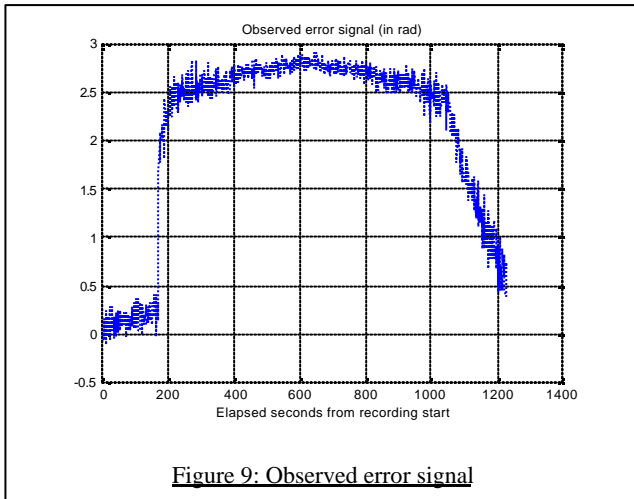

Figure 9: Observed error signal

it is shown on figure 8. The initial loop bandwidth has been set to 20Hz. When the FAB algorithm has been turned on, the bandwidth has quickly converged toward its minimal value (set to 5Hz) because of the low dynamics at the beginning of the run. After that, the algorithm has opened the loop when dynamics increased, and closed it when dynamics decreased. Figure 9 shows the evolution of the error signal at the output of the discriminator. We have implemented an ARCTAN 4-Quadrants discriminator in our PLL. The lock range of this discriminator is in the range of  $-\pi$  to  $\pi$ . We have limited

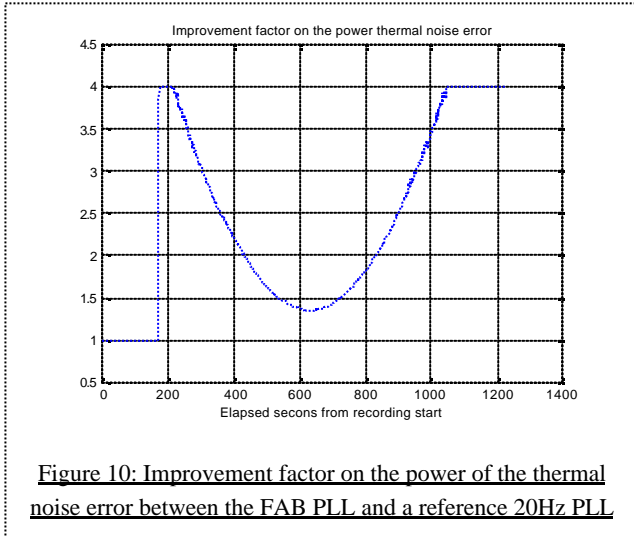

Figure 10: Improvement factor on the power of the thermal noise error between the FAB PLL and a reference 20Hz PLL

it in the range of  $-3$  to  $3$  radians in the algorithm to decrease the probability of loss of lock. As it has been predicted by the theory, optimal loop bandwidth provided by the FAB algorithm results in an error signal composed

of bias plus noise that stays always in the lock range of the loop.

To compare the theoretical power of the thermal noise on the phase measurements of the FAB PLL with a reference PLL with a fixed bandwidth of  $B$  Hz, it is necessary to remind the expression of this error power. This expression for a  $B$  Hz PLL is

$$S_{ThermalError}^2 = \frac{B}{C/N_0} \left( 1 + \frac{Bp}{2 \cdot C/N_0} \right) \text{ (in rad}^2\text{)}$$

Consequently, the rate between the thermal noise on phase measurements of a  $B$  Hz reference PLL and the FAB PLL is

$$\frac{S_{BHzPLL}^2}{S_{FABPLL}^2} = \frac{B}{B_{FABPLL}}$$

We have plotted this rate for a reference PLL with a fixed bandwidth of 20Hz on figure 10. We can see that the power of the thermal noise error in the FAB PLL is 3 times lower than in the 20Hz PLL much more than 50% of the time.

## CONCLUSION

This implementation of the FAB algorithm in a real GPS receiver has shown that this method is operational in a real case context. The results of the test have shown that the algorithm provides an efficient solution to track high dynamics signals with a low power of noise on the phase measurements, especially if high dynamics occurs not any time.

## ACKNOWLEDGMENTS

The authors wish to thank ASPI and CNES for supporting this research and STNA for having provided technical assistance.

## REFERENCES

- [1] E.D. KAPLAN - 'Understanding GPS, principles and applications' - Artech House - 1996
- [2] F. LEGRAND, C. MACABIAU - 'Improvement Of Pseudorange Measurements Accuracy By Using Fast Adaptive Bandwidth Lock Loops' - proceedings of the Institute Of Navigation International Technical Meeting, September 2000 - Salt Lake City, USA
- [3] W.C. LINDSEY, C.M. CHIE - 'A survey of digital phase-locked loops' - Proceeding of the IEEE, Vol. 69, No 4 - April 1981
- [4] E.I. JURY - 'Theory and application of the z transform method' - Ed John Wiley & Sons, Inc. - 1964