

GPS acquisition solution for use cases in all types of environments

Hanaa Al Bitar-El Natour, Anne-Christine Escher, Christophe Macabiau, Olivier Julien, Michel Monnerat

► To cite this version:

Hanaa Al Bitar-El Natour, Anne-Christine Escher, Christophe Macabiau, Olivier Julien, Michel Monnerat. GPS acquisition solution for use cases in all types of environments. ION GNSS 2006, 19th International Technical Meeting of the Satellite Division of The Institute of Navigation, Sep 2006, Fort Worth, United States. pp 1327-1335, 2006, <<http://www.ion.org/publications/abstract.cfm?articleID=6878>>. <hal-01021794>

HAL Id: hal-01021794

<https://hal-enac.archives-ouvertes.fr/hal-01021794>

Submitted on 31 Oct 2014

HAL is a multi-disciplinary open access archive for the deposit and dissemination of scientific research documents, whether they are published or not. The documents may come from teaching and research institutions in France or abroad, or from public or private research centers.

L'archive ouverte pluridisciplinaire **HAL**, est destinée au dépôt et à la diffusion de documents scientifiques de niveau recherche, publiés ou non, émanant des établissements d'enseignement et de recherche français ou étrangers, des laboratoires publics ou privés.

GPS Acquisition Solution For Use Cases in all Types of Environments

Hanaa A. EL-NATOUR, *ENAC/TeSA*
Anne-Christine ESCHER, *ENAC*
Christophe MACABIAU, *ENAC*
Olivier JULIEN, *ENAC*
Michel MONNERAT, *Alcatel Alenia Space*

BIOGRAPHY

Hanaa A. EL-NATOUR graduated as a Network and telecommunications engineer in 2002 from the Lebanese University of Beirut, Lebanon. She has a masters and research degree in Networks and Telecommunications from the ENSEEIHT in Toulouse, France (2003). Currently, she is a PhD student at the ENAC (Ecole Nationale de l'Aviation Civile), in Toulouse, France. She is investigating different signal processing techniques for GPS positioning.

Anne-Christine ESCHER graduated as an electronics engineer in 1999 from the ENAC in Toulouse, France. Since 2002, she has been working as an associate researcher in the signal processing lab of the ENAC. She received her Ph.D. in 2003.

Christophe MACABIAU graduated as an electronics engineer in 1992 from the ENAC in Toulouse, France. Since 1994, he has been working on the application of satellite navigation techniques to civil aviation. He received his Ph.D. in 1997 and has been in charge of the signal processing lab of the ENAC since 2000.

Olivier JULIEN is an assistant professor at the signal processing laboratory of ENAC, Toulouse, France. His research interests are GNSS receiver design, GNSS multipath and interference mitigation and GNSS interoperability. He received his B.Eng in 2001 in digital communications from ENAC and his PhD in 2005 from the Department of Geomatics Engineering of the University of Calgary, Canada.

Michel Monnerat graduated from the ENSICA (Ecole Nationale Supérieure d'Ingénieur de Constructions Aéronautiques) engineering school. After being involved within Alcatel Space in many radar programs, in charge of the onboard processing of the ARGOS / SARSAT payload, he has been involved in the Galileo program

since 1998, for the signal design and performance aspects. He is currently involved in Alcatel Space LBS programs.

ABSTRACT

The dramatic increase of Location Based Services and other location and navigation applications gives rise to a crucial need to improve positioning solutions. Currently, the American GPS is the only operational satellite based positioning system as the European Galileo system will be operational by 2010. Hence, this paper only deals with GPS receivers. The Time To First Fix (TTFF) and the sensitivity are the key drivers for their performance evaluation. The TTFF is the time needed for a GPS receiver to provide a first position. The sensitivity is the ability of a GPS receiver to acquire weak signals. For commercial solutions, an efficient receiver is a receiver with a reduced TTFF and high sensitivity. But generally, enhancing the sensitivity results in an increased TTFF and vice versa. In this paper, a use case will be defined which proposes an optimized solution to be applied in each type of GPS terrestrial environments, namely rural, urban and indoor environments.

I. INTRODUCTION

Navigation solutions are being more and more integrated in our daily life. From the American E911 and the European E112 mandates, to Location Based Services (LBS), the need for positioning is henceforth absolutely justified.

These LBS positioning applications involve many types of working environments which characteristics are very different from each other. These environments may be generally classified as:

- Rural environments: They refer to unobstructed environments with very good satellites visibility. In such

environments many direct Line Of Sight (LOS) satellite signals are generally available at the receiver level. This means that the received signal is strong enough to be easily acquired and tracked. Hence the final position is computed quite accurately.

- Urban environments: In these environments a LOS satellite signal is not always available. The signal generally reaches the receiver after multiple reflections or after going through foliage for example, giving rise to multipaths and shadowing phenomena. This causes the signal to be attenuated compared to the theoretical LOS signal. Furthermore, the presence of non-LOS signals leads to inaccurate solutions, since they have different delays, or are very attenuated, compared to the original signal. Cross-correlations may also appear if two signals have different strength.

- Indoor environments: These environments refer to in-building sites, where a LOS is not likely to be available at the receiver. In most cases the signal must cross one or several concrete walls and ceilings to reach the receiver. This implies an important attenuation of the signal power, depending on the building materials. Note that cross-correlation problems may also arise in the case of two signals with very different signal strengths (with one reaching the receiver through a wall, and the other one going through a window for example) reach the receiver. Thus generally speaking, the urban and indoor environments have practically the same problems, but these problems are much more significant in indoor environments.

The main goal of satellite positioning is primarily to provide a worldwide solution in all kinds of environments. This solution is subject to precision and computation speed requirements, especially when dealing with real time commercial applications. These parameters are determined by the receiver sensitivity and TTFF.

This paper aims at developing a "Use Case" solution: it consists in describing multiple optimized GPS acquisition signal processing techniques. For rural environments the main objective is rather the reduction of the TTFF, since there are no sensitivity problems. Thus the corresponding solution essentially reduces the TTFF, but introduces some losses which are tolerable in such environments where the signals are received with strong power. For urban and indoor environments, the solution proposed attempts to find the best compromise between the TTFF and GPS sensitivity, thus providing a fast solution with equal or enhanced sensitivity. The sensitivity or the TTFF will be respectively privileged according to the studied environment. When no sufficiently strong signal is available, the algorithm mainly enhances the sensitivity at the expense of the

TTFF. One of the proposed algorithms is the Sum Of Replicas (SOR) algorithm that was presented at the ION NTM 2006 [El Natour et al. 2006]. This algorithm enhances the TTFF by computing more than one satellite at once. This is done by correlating the received signal with a sum of locally generated replicas rather than correlating it with only one. The other algorithms are all sequential algorithms, meaning that the satellites are sequentially searched for, but they involve enhancements compared to the classical algorithm, namely the TTFF, determined by the algorithm complexity, with no or negligible loss in sensitivity. The main idea for these algorithms complexity reduction is to carry out coherent integration by rather summing 1ms correlation results. The transverse FFT algorithm further considers the signal phase to be constant over a period of 1ms and for small Doppler shifts. The SOR is further optimized by applying the transverse FFT algorithm as acquisition process.

All of these algorithms are based on the Assisted GPS concept to improve its false detection ability. That is, Assistance Data (AD) from the GSM network is used to calculate approximate values of the Doppler frequency and code delay for each satellite, and provides a raw user position within a GSM cell [LaMance 2002]. Thus the GPS receiver is supposed to be introduced into a cellular mobile phone. Consequently, the AD disseminated by the telecommunication channel is used by the receiver in order to improve its sensitivity and to decrease the TTFF. Typically in cold start, the AD set required is composed of:

- The reference time
- The reference location
- The navigation model (Ephemeris)
- The ionosphere correction

The reference time is known with an uncertainty of $\pm 2s$ due to the signal transfer through the unsynchronised GSM network. The uncertainty on the reference location is equal to the considered GSM cell size (cell ID method used to find a coarse location using the GSM network).

Using this information allows for a coarse estimation of each satellite code delay and doppler. Then once a first satellite is acquired this uncertainty can be removed and no doppler search is necessary for the subsequent satellites. This principle will be applied in what follows. For the first satellite, a doppler range of 2KHz is tested.

The paper is organized as follows: First the studied algorithms are described. The subsequent section reports on a set of experiments conducted to compare these algorithms with each other. In conclusion, a use case solution is defined with a paper summary following.

II. ALGORITHMS BRIEF DESCRIPTION

II.1 The sum after correlation algorithm

This method allows for using longer coherent integrations, for enhanced sensitivity [Van Diggelen 2001], without increasing the signal block size. In fact only $1ms$ signal blocks are treated at once, and the coherent integration is performed by summing these blocks.

Suppose that the received signal is (without loss of generality, the carrier initial phase is considered to be null):

$$s(t) = A.d(t - \tau).c(t - \tau).e^{i[2\pi(L_1 + f_d)t]}$$

with A the signal amplitude, $d(t)$ the data bits, $c(t)$ the C/A code chips, τ the signal delay, L_1 the carrier frequency, and f_d the Doppler frequency.

For a coherent integration over $T_p = 10ms$ for example, the Doppler bins tested are of $\frac{1}{2T_p} = 50 Hz$ [Kaplan, 1996]. The correlation is represented by:

$$R(\hat{\tau}, \hat{f}_d) = \int_0^{10ms} s(t - \tau).c(t - \hat{\tau}).e^{i[2\pi(f_0 + \hat{f}_d)t]} .dt$$

Where: $s(t)$ is a $10ms$ section of the signal. The same goes for $c(t)$. $\hat{\tau}$ and \hat{f}_d are the estimated code delay and Doppler frequency respectively.

This function is calculated repeatedly for all the possible values of the code delay (over one code period of 1023 chips).

$R(\hat{\tau})$ can be written as:

$$R(\hat{\tau}) = \sum_{k=1}^{10} \int_{(k-1).1ms}^{k.1ms} s(t_k - \tau).c(t_k - \hat{\tau}).e^{i[2\pi(f_0 + \hat{f}_d)t_k]} .dt_k$$

In this equation $s(t)$ and $c(t)$ are $1ms$ blocks of the received signal and the code replica respectively. Globally, N points are used to calculate this correlation for each value of the code delay.

Using the Fast Fourier Transform (FFT), the expression of the correlation becomes:

$$R(\hat{f}_d) = IFFT \left\{ FFT [s(t)].FFT [c(t).e^{i[2\pi(f_0 + \hat{f}_d)t]}] \right\}$$

With $s(t)$ and $c(t)$ having a duration of $10ms$.

The correlation can also be written as:

$$R(\hat{f}_d) = \sum_{k=1}^{10} IFFT \left\{ FFT [s(t_k)].FFT [c(t_k).e^{i[2\pi(f_0 + \hat{f}_d)t_k]}] \right\}$$

Where $s(t_k)$ is the k^{th} $1ms$ section of signal.

The advantage of this algorithm [D. Akopian 2005, Mark C. 2001] is that it is faster than the classical one since computing a Fourier Transform with N points, as in the classical case, is much slower than computing k Fourier Transforms with N/k points. Indeed, an FFT with N points requires $N \log N$ additions and $\frac{N}{2} \log N$ multiplications, whereas k FFT with $N/10$ points each one for example will require $N \log N/k$ additions and $N/2 \log N/k$ multiplications. This reduction in computation complexity is done twice, first when converting to the frequency domain using FFT, and when converting back to the time domain using IFFT.

On the other hand, such algorithm allows for the implementation of a sensitivity improvement technique by avoiding an possible phase jump or shift due to bits transitions for the correlation result within $1ms$. This is done by performing a linear correlation rather than a circular correlation between the signal and the code imposed by the FFT algorithm. In fact, $2ms$ of signal are considered rather than $1ms$ for a $1ms$ correlation result, it is then correlated with a zero padded version of the code; the resulting correlation function is truncated to $1ms$. This is not possible in the classical case since it introduces a large computation charge. This optimization is considered in this paper in all of the following algorithms. However this technique does not prevent energy loss due to data bit transitions occurring within a long total coherent integration time.

II.2 The sum before correlation algorithm

The principle of this method is the same as that of the previous one. The difference here is that the coherent integration is performed before converting to the frequency domain. The summation is carried out after removing the signal Doppler: $T_p ms$ of the signal are summed together then converted to the frequency domain. The subsequent steps are the same as in the previous method. But this time, the correlation can be written as:

$$R(\hat{f}_d) = IFFT \left\{ FFT \left[\sum_k s(t_k).e^{i[2\pi(f_0 + \hat{f}_d)t_k]} \right].FFT [c(t_1)] \right\}$$

This algorithm allows for reducing the number of FFT performed by a factor depending on the coherent integration duration needed (a factor of 4 for a coherent integration over $4ms$). However, theoretically some losses may appear due to code doppler which is not accurately compensated during the pre-integration phase, because the total signal is summed into a $1ms$ block, and therefore the local code replica is only $1ms$ long.

II.3 The transverse FFT algorithm

With the transverse FFT, the frequency domain is first divided into large steps of 500Hz which correspond to $T_p = 1ms$. Then, small doppler bins, according to the coherent duration needed, are defined within the large bins. Therefore, the frequency bins are defined as: $f_d(i, j) = f_i + j * \delta f$, where $f_i = f_1 + i * 500$ and f_1 the first frequency to be tested. f_i sweeps all the large bins to be tested, and $j * \delta f$ sweeps the small bins to be tested within each large bin.

Here again, the coherent integration is accomplished by summing $T_p ms$ of signal after FFT-IFFT, as already mentioned.

This method would have been equivalent to the classical algorithm if the signal phase was constant over 1ms steps. But this is not the case in real GPS signals. The classical GPS signal expression is:

$$s(t) = A.d(t - \tau).c(t - \tau).e^{i[2\pi(f_0 + f_i).t]} . e^{i[2\pi j \delta f t]}$$

The correlation result is expressed as:

$$R(f_i + j \cdot \delta \hat{f}) = \sum_{k=1}^{10} IFFT \{ FFT[s(t_k)] FFT[c(t_k)] e^{i[2\pi(f_0 + f_i + j \delta \hat{f}).t]} \}$$

This correlation must be computed for each frequency bin.

With the transverse FFT the phase $[2\pi j \delta \hat{f} t]$ is supposed to be constant over one code period of 1ms and the signal is approximated by:

$$s(t) = A.d(t - \tau).c(t - \tau).e^{i[2\pi(f_0 + f_i).t]} . e^{i[2\pi j \delta \hat{f} \cdot floor(t/1ms)]}$$

Thus the local counterpart is generated such that the phase is constant over 1ms steps. The correlation becomes:

$$R(f_i + j \cdot \delta \hat{f}) = \sum_{k=1}^{10} e^{i[2\pi j \delta \hat{f} \cdot floor(t/1ms)]} . IFFT \{ FFT[s(t_k)] FFT[c(t_k)] e^{i[2\pi(f_0 + f_i).t]} \}$$

This way, the correlation is computed only for large bins and the results corresponding to smaller bins are obtained by multiplying the correlation by complex exponential as in the former equation.

The advantage of this algorithm is to further reduce the TTFF, since it reduces the number of FFTs and IFFTs needed to be performed compared to a classical FFT algorithm. For a coherent integration of 10ms for example, the Doppler resolution is of 50Hz. If a Doppler range of 2KHz needs to be tested, the number of FFT-IFFTs carried out is $10 * 2000 / 50 = 400$, whereas with the transverse FFT algorithm we only need $10 * 2000 / 50 = 40$ FFT-IFFTs couples.

However, some losses may occur due to assumption of a constant phase over 1ms steps and for small doppler residuals.

II.4 The SOR algorithm

The general principle is to correlate the incoming signal with the sum of C/A code replicas rather than correlating it with only one replica. This yields to a parallel search for all visible satellites rather than searching for them sequentially. The acquisition process is obviously speeded up. Visible satellites PRN are known a priori thanks to the AGPS AD.

The acquisition is realized according to the scheme presented in figure 3:

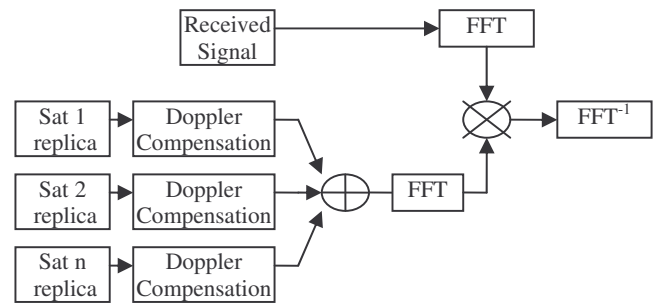

Figure 1: SOR algorithm principle

Each satellite PRN code has its own delay, and hence corresponds to one of the acquisition peaks detected in the correlation function. At this stage, the issue is to determine the proper correspondence between satellite PRNs and acquisition peaks. This correspondence is done first by trying to locate each acquisition peak within a code delay window. Indeed assuming that the reference location, the reference time and the navigation model are known thanks to AD, the receiver can compute the differential time of arrival between the satellites and this information can be used to identify the correlation peak pattern. The correspondence is then possible since each code delay window is already assigned to a satellite PRN code as it is shown in figure 5 below.

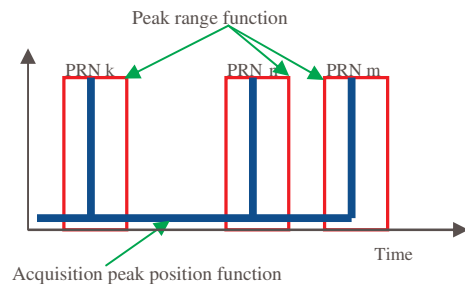

Figure 2: Satellites identification process using the code delay ranges function (red plot) estimated by the AD. The blue plot corresponds to the acquisition code delay positions

However, this identification process is not possible if for example, two or more satellites have the same or close code delays. Thus a discrimination process

should first be undertaken. A classification in groups of the visible satellites according to their respective expected code delay is realized to avoid correlation peak collisions. Obviously, the accuracy of the provided code delay is tremendously important and the wider the code delay windows, the fewer satellites per group.

This way of searching for a peak within a predetermined range may also be used in the case of the other algorithms. It enables to eliminate cross-correlation peaks which are not included in any code delay range. As explained in [El Natour et al. 2006], the more satellites per group, the greater is the complexity reduction with respect to a standard algorithm. But having too many satellites per group may affect the receiver sensitivity.

Note that the acquisition process used here is based on the sum after correlation algorithm.

II.5 The optimized SOR algorithm

As explained before, the SOR can be further optimized by introducing the transverse FFT algorithm as the acquisition method. This significantly enhances its performances compared to the classical SOR algorithm. No other enhancements could be introduced in this algorithm (sum before correlation for example).

The simulation results presented in this paper only deal with the optimized SOR.

III. ALGORITHM PERFORMANCE COMPARISON

The algorithms performance depend on many parameters: The duration of the coherent integration (T_p), the number of non-coherent accumulations (M), the incoming signal C/N_0 value, the Doppler frequency bins to be tested, the uncertainty on the receiver position (determined by the considered cell size).

The sequential search for the visible satellites is carried out after sorting them based on their elevation angles, from the highest to the lowest. This is a way to increase the probability of having the strongest signals being processed at first to guarantee a faster solution availability.

The first test will consider similar conditions for all of the algorithms to compare their performance, computation time and sensitivity, with equal parameters. The signals used were generated using a SPirent STR4500 GPS signal generator and an NI-6534 acquisition card. The signals have all the same C/N_0 ratio, with each one comprising 9 to 10 visible satellites. The receiver is static throughout the simulation. In this experiment, 3 signals with different C/N_0 will be studied: 42, 27, 17 dBHz.

For each C/N_0 , values for T_p and M are chosen such that all of the satellites can be successfully acquired, and kept the same for all of the algorithms.

Two parameters are essentially compared throughout the simulation results: The time needed to acquire using a matlab implementation, and the C/N_0 estimated with each algorithm. A signal is said to be successfully acquired if the correlation maximum corresponds to the right code delay and doppler values. According to each test, all or a certain number of satellites are needed to be acquired in order to be able to compute a more or less precise position.

Table 1 shows the values chosen for each C/N_0 . Accordingly a value of the cell size was also chosen. The considered values for the C/N_0 are characteristic of different environments: rural, urban and indoor environments respectively. The user position uncertainty (Δx) reflecting the cell size is accordingly chosen.

C/N_0 (dBHz)	42	27
T_p (ms)	4	10
M	5	15
Δx (Km)	30	10

Table 1: parameters used for test A

The second test will consider the same signals with three characteristic C/N_0 ratios. This test focuses on the minimum time needed for each algorithm to successfully acquire a signal with a given C/N_0 . The coherent integration duration will be the same for all of the algorithms, in order to insure that the number of frequency bins tested is the same. It is mainly the number of non-coherent integration M which will be optimized. The minimum required M will be searched for each satellite in the case of the sequential algorithms. The final value held for M is the one that insures a successful acquisition for a certain number of satellites. The uncertainty on the user position is again chosen according to the considered C/N_0 . The parameters used for this test are illustrated in table 2 below

C/N_0 (dBHz)	42	27	17
T_p (ms)	1	4	10
M	Variable	Variable	Variable
Δx (Km)	30	10	1
number of satellites successfully acquired	10/10	7/10	4/10

Table 2: parameters used for test B

The next sections report on the tests conducted with the results obtained in each case.

III.1 Test A-1: $C/N_0 \cong 42 \text{ dBHz}$, $T_p = 4\text{ms}$, $M = 5$, $\Delta x = 30\text{Km}$

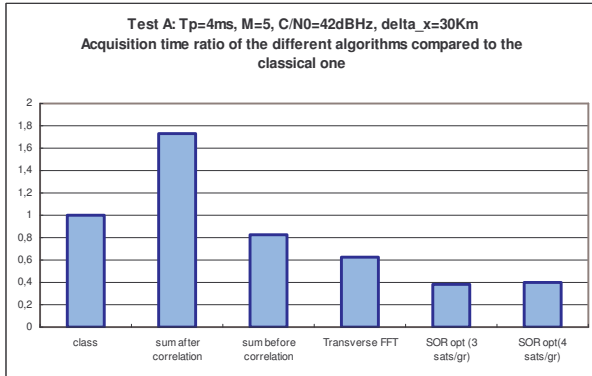

Figure 3: Acquisition time ratio of the different algorithms compared to the classical one for a signal of 42dBHz, with fixed M and Tp

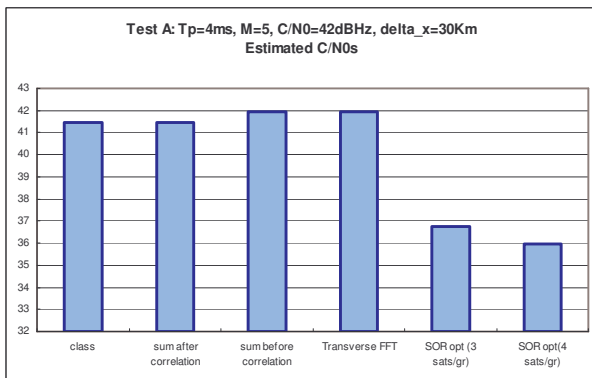

Figure 4: Estimated C/N0s for a signal of 42dBHz, with fixed M and Tp

Figures 3 and 4 show that the sum before correlation and the FFT transverse algorithms are faster than the classical one, with ratios of 0.87 and 0.58 respectively. In terms of sensitivity, the sum after correlation, sum before correlation and transverse FFT algorithms have approximately the same performance as that of the classical algorithm (The small increase in sensitivity noticed in the case of the sum before correlation and the transverse FFT algorithms is due to estimation unaccuracy because the signal used for this estimation is very short).

As for the optimized SOR algorithm with groups of 3 satellites, it is faster than the transverse FFT with a 0.38 ratio compared to the classical algorithm. This ratio is approximately the same for groups of 4 satellites (0.4). But in terms of sensitivity, it introduces a significant loss

in the estimated C/N_0 which increases with the number of satellites per group, as expected.

Test A, with a signal at 27dBHz will be presented next.

III.2 Test A-2: $C/N_0 \cong 27 \text{ dBHz}$, $T_p = 10\text{ms}$, $M = 15$, $\Delta x = 10\text{Km}$

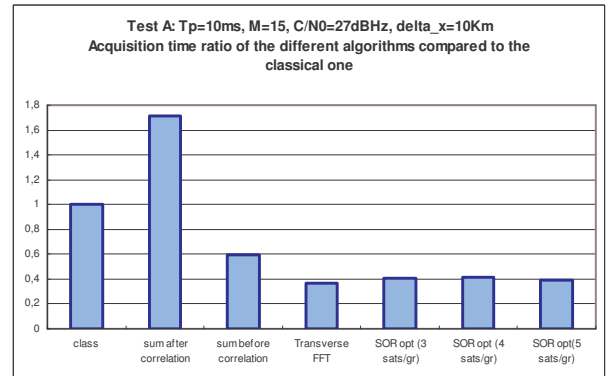

Figure 5: Acquisition time ratio of the different algorithms compared to the classical one for a signal of 27dBHz, with fixed M and Tp

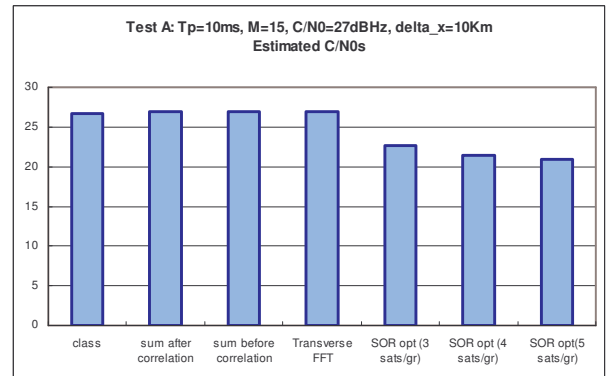

Figure 6: Estimated C/N0s for a signal of 27dBHz, with fixed M and Tp

It can be noticed here that number of satellites tested per group is greater than in the previous test. In fact, for a lower uncertainty on the user position more satellites can be grouped together since the code delay windows estimated using the AD are narrower and more satellites can be treated at once without intersection between these windows. This is why groups of 5 satellites can be tested.

The results of this test meet with those of the previous test in that the transverse FFT and the SOR algorithm are faster than the classical one. However, the acquisition time ratios of the sum before correlation and the transverse FFT algorithms are lower than in the previous test: 0.6 and 0.36 respectively against 0.87 and

0.58 before. This is because the coherent integration used for this test is $10ms$ rather than the $4ms$ used in the previous test. In fact, the classical algorithm complexity increases with the coherent integration duration, since the number of samples submitted to the FFT-IFFT couple, is greater. This is not the case for the other algorithms since they all process only $1ms$ of signal at once. This explains the differences in complexities noticed in this test. On the other hand, the optimized SOR is comparable to the transverse FFT algorithm and is no more faster. Losses in C/N_0 ratio also increase with the number of satellites per group.

Gathered results of test A show that in similar conditions, the transverse FFT and the optimized SOR algorithms are much faster than the other algorithms. However losses in sensitivity are observed for the SOR while no losses are noticed with the transverse FFT algorithm. One way to compensate for these losses is to process longer blocks of signal. But this may increase the acquisition time needed for successful acquisition. Thus the following tests compare the minimum time needed for each of these algorithms to successfully acquire a signal with a given C/N_0 .

III.3 Test B-1: $C/N_0 \cong 42 \text{ dBHz}$, $T_p = 1ms$, $\Delta x = 30Km$

In this experiment, the minimum M needed to successfully acquire 10 satellites out of 10 is searched for. Since M will be different from one algorithm to another in this test, the signal duration used for acquisition will also be different; hence, the signal observation time will be further considered with the acquisition time. The results are depicted in figures 7 and 8.

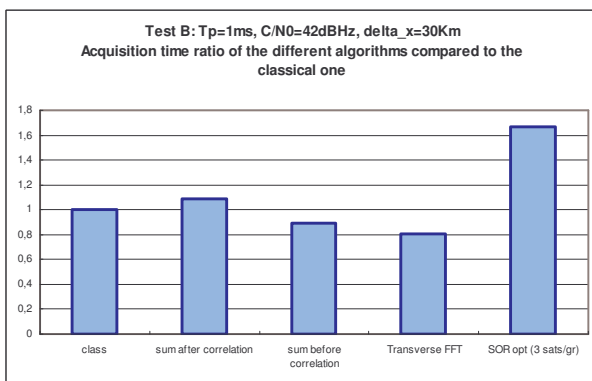

Figure 7: Acquisition time ratio of the different algorithms compared to the classical one for a signal of $42dBHz$, with fixed T_p

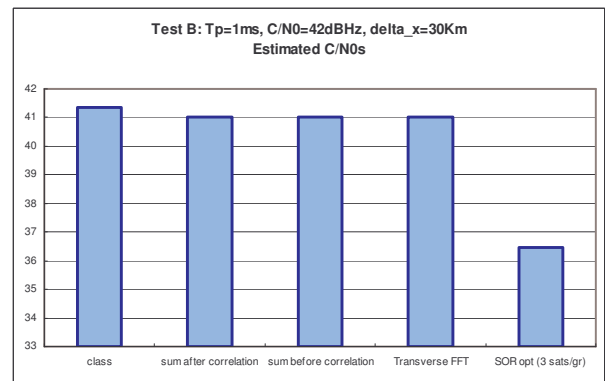

Figure 8: Estimated C/N_0 s for a signal of $42dBHz$, with fixed T_p

The first thing to be mentioned here is that the sequential algorithms are more comparable to the classical one, with ratios of 0.9 and 0.8 compared to 0.87 and 0.58. This is obvious since the former are optimised to speed up the coherent integration process. Thus for a coherent integration over $1ms$ their complexities are comparable to the classical algorithm or even worse.

The SOR is not interesting in this case, since it is much slower than the classical algorithm. This is because the loss in the C/N_0 could not be compensated by longer integrations without increasing the overall time needed.

In terms of sensitivity, the results are comparable to those obtained previously.

III.4 Test B-2: $C/N_0 \cong 27 \text{ dBHz}$, $T_p = 4ms$, $\Delta x = 10 Km$

This test has been conducted with the assumption that only 7 satellites out of 10 are needed to be successfully acquired. Thus, the minimum value of M retained is that corresponding to a successful acquisition of the first satellites. The results are illustrated in figures 9 and 10.

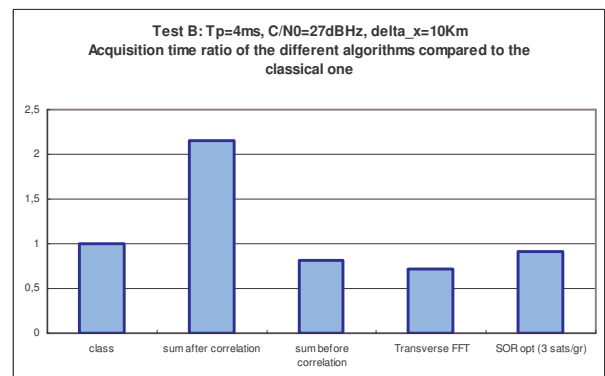

Figure 9: Acquisition time ratio of the different algorithms compared to the classical one for a signal of $27dBHz$, with fixed T_p

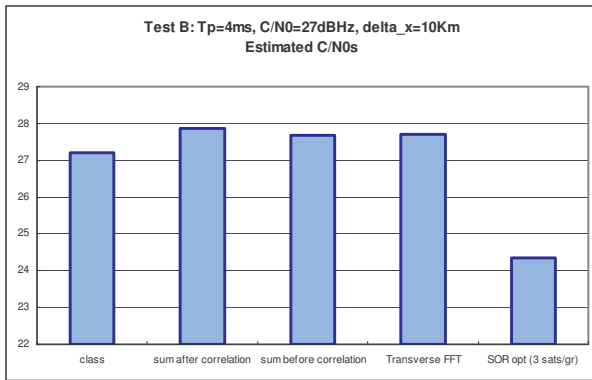

Figure 10: Estimated C/N0s for a signal of 27dBHz, with fixed Tp

In this experiment the sequential algorithms are faster than the classical one, except for the sum after correlation. The optimized SOR needs more time when the number of satellites per group increases, and is slower than the sequential algorithms. The transverse FFT is still the most interesting in speed and sensitivity performances.

III.5 Test B-3: $C/N_0 \cong 17 \text{ dBHz}$, $T_p = 10 \text{ ms}$, $\Delta x = 1 \text{ Km}$

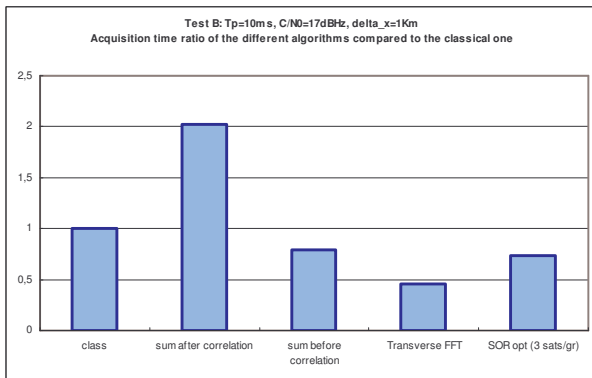

Figure 11: Acquisition time ratio of the different algorithms compared to the classical one for a signal of 17dBHz, with fixed Tp

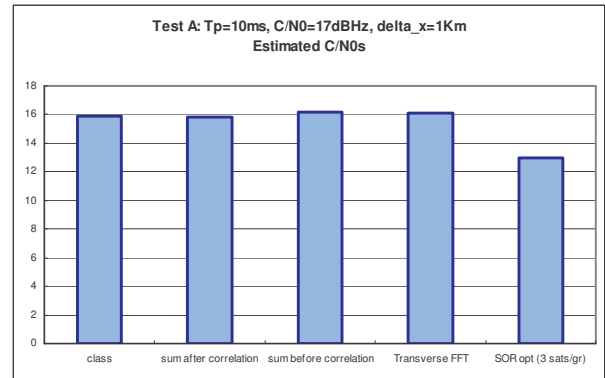

Figure 12: Estimated C/N0s for a signal of 17dBHz, with fixed Tp

In this experiment also the SOR needs more time than the transverse FFT which once again has the best speed and sensitivity performance.

IV. CONCLUSION

The tests conducted lead to many conclusions:

In similar conditions, for strong signals (42 dBHz), a coherent integration of 1ms is largely sufficient for a successful acquisition. In this case, the algorithms which search for the satellites one by one are not interesting except for the transverse FFT and the optimized SOR are faster.

For weaker signals (27 dBHz), the transverse FFT and the SOR are still faster, although the SOR introduces significant loss in sensitivity.

For fixed Tp and C/N0, but variable M, when a strong signal is received, the sum before and the transverse FFT are more interesting than the other algorithms. The optimized SOR is not interesting since it needs much more time than the others to compensate for the loss it introduces. The same results were obtained for weaker signals.

In summary, the sequential algorithms sensitivity performance is comparable, but the transverse FFT is the most interesting in terms of acquisition time. The current version of the SOR algorithm is not interesting, unless the receiver uses a fixed total integration time ($M \cdot T_p$). If that total integration time is kept fixed for the SOR to be efficient that time needs some how to be over estimated.

V. REFERENCES

[El Natour et al. 2006] – Hanaa El Natour, Michel Monnerat, Anne-Christine Escher, Christophe Macabiau, Marie-Laure Boucheret (2006), “A new algorithm to reduce AGPS acquisition TTFF”, in proceedings of the ION NTM January 2006

[Van Diggelen 2001] - F. van Diggelen (2001), "*Global Locate Indoor GPS Chipset and Services*", Global Locate, Inc., 1515, in proceedings of the ION GPS 2001

[LaMance 2002] - Jimmy LaMance, Javier DeSalas, Jani Jarvinen (2002), "*Assisted GPS: A Low-Infrastructure Approach*", GPS World

[Kaplan 1996] - Elliott D. Kaplan (1996), "*Understanding GPS: Principles and Applications*", Artech House, Norwood, MA

[D. Akopian 2005] - D. Akopian (2005), "*Fast FFT based GPS satellite acquisition methods*", IEE, Radar Sonar Navigation, Vol. 152, No. 4

[Mark C. 2001] – Sullivan Mark C. (2001), "*System and method for fast code phase and carrier frequency acquisition in GPS receiver*", United States Patent No. 7.027.486, September 10