



**HAL**  
open science

# Digitization guidelines for a direct sampling dual-band GNSS receiver for civil aviation

Antoine Blais, Christophe Macabiau, Olivier Julien

► **To cite this version:**

Antoine Blais, Christophe Macabiau, Olivier Julien. Digitization guidelines for a direct sampling dual-band GNSS receiver for civil aviation. ENC 2011, European Navigation Conference, Nov 2011, London, United Kingdom. pp xxx. hal-01022312

**HAL Id: hal-01022312**

**<https://hal-enac.archives-ouvertes.fr/hal-01022312>**

Submitted on 29 Sep 2014

**HAL** is a multi-disciplinary open access archive for the deposit and dissemination of scientific research documents, whether they are published or not. The documents may come from teaching and research institutions in France or abroad, or from public or private research centers.

L'archive ouverte pluridisciplinaire **HAL**, est destinée au dépôt et à la diffusion de documents scientifiques de niveau recherche, publiés ou non, émanant des établissements d'enseignement et de recherche français ou étrangers, des laboratoires publics ou privés.

# Digitization Guidelines for a Direct Sampling Dual-Band GNSS Receiver for Civil Aviation

Antoine Blais, Christophe Macabiau, Olivier Julien  
(*École Nationale de l'Aviation Civile, France*)  
(Email: antoine.blais@enac.fr)

This paper studies the application of the Direct Sampling technique to GNSS receivers dedicated to Civil Aviation usage. After describing the specific spectral environment to be withstood by such receivers, an analysis of the digitization process is conducted, leading to design guidelines.

## KEY WORDS

1. Direct Sampling    2. Dual band    3. GNSS receiver    4. Civil Aviation

## 1. Introduction

Software Radio is now a reality and in most new designs the signal processing operations implemented by hardware components are limited to frequency conversions, pre-filtering and Automatic Gain Control before an ADC in an RF Front-End. It enables design of versatile transmitter and receiver, capable of handling a wide variety of protocols and signals where yesterday a specific equipment was necessary for each one.

The progress expected in the near future will allow to go further on the hardware simplification, that is to use Direct Sampling. More exactly, the RF Front-End could be reduced to a wide band filter combined with a LNA, and then the ADC, as represented in Figure 1.

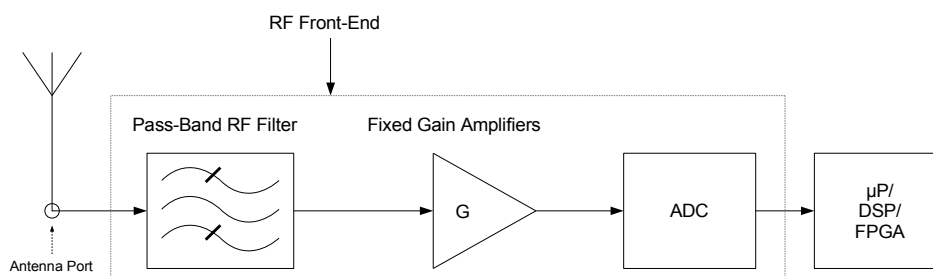

Figure 1. Main elements of an ideal Direct Sampling receiver

In particular for the next generation of GNSS receivers for Civil Aviation, designed for working on both GPS and Galileo constellations and both L5/E5 and L1/E1 signals, it is interesting to analyze the feasibility of sampling directly both bands, removing the necessity of two complete demodulation chains. But this design must be compatible with the requirements found in Civil Aviation standards, such as Minimum Operational Performance Specification (MOPS) documents, edited by RTCA [1], [2], [3] and EUROCAE [4]. A key point is the weakness to out-of-band interference due to the simplification of the RF Front-End which turns into a lack of selectivity.

The aim of this article is to convert requirements of robustness against interferences into design guidelines for the digitization process, that is to assess the sampling frequency and the number of bits of the quantifier.

Direct Sampling architectures for multi-band GNSS receivers have already been studied in some other publications as [5], [6], but our approach includes the interference threat and goes further into hardware simplification by removing the need of AGC.

The analysis begins in part 2 with a presentation of the interference environment specific to the Civil Aviation operations from en-route to NPA, which implies a proposed sampling strategy detailed in part 3 if Direct Sampling is to be used. Then in part 4 the quantization aspect of digitization is studied to assess the number of bits required. Finally a conclusive part 5 ends this paper.

## 2. Civil Aviation requirements for GNSS Receivers

If direct Sampling is to be used, as sampler is located closer to the antenna than in classical architecture (heterodyne or homodyne), close attention must be paid to the RF filtering part of such a receiver to avoid aliasing. In order to design the RF Front-End correctly, an evaluation of the spectral content of signals at antenna output must be conducted. And not only considering the useful GNSS navigation signals but also all the undesired electromagnetic waves picked up by the antenna. The latter are of premium importance in Civil Aviation as they can disturb the normal operation of the receiver, possibly leading to a degradation of the navigation function.

This threat has been quantified by standardization committees and is summarized in three documents, [7] and [8] for respectively the L1 and L5 GPS signals, and [4] for both E1 and E5 Open Service Galileo signals. Considering that, from the spectral standpoint, E1 band equals L1 band and E5 band includes L5 band and that the MOPS for Airborne Open Service Galileo Satellite Receiving Equipment document [4] is the only one which considers a dual band receiver in a unified way, [4] will be used as a single reference in the rest of this paper. Anyway the levels of interference described in [7], [8], [4], are comparable. Figure 6 is a graphical representation of both Carrier Wave / Narrow Band (CW/NB) and Pulsed interference masks at antenna port specified in [4]. These masks define the maximal power of the interfering signals below which all the minimum performance required for the receiver shall be achieved.

What is more, [4] also specifies the requirements for active antenna to be used on board (standards [1], [2], [3] relative to GPS satellite receiving equipment also consider the use of a passive antenna, but this practice seems deprecated). Figure 2 illustrates the corresponding required minimum preamplifier selectivity in both E1 and E5 bands. According to this point, the diagram of an ideal Direct Sampling GNSS receiver can then in this case be refined as shown in Figure 3.

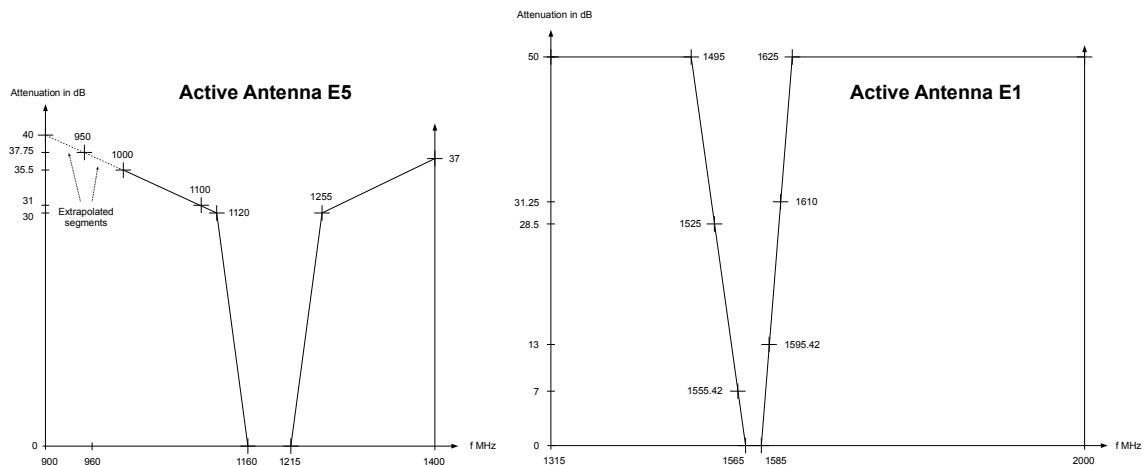

Figure 2: Minimum required selectivity of the active antenna preamplifier [4]

Using the minimum preamplifier selectivity curves it is also possible to deduce the maximum interference levels at the receiver input as drawn in Figure 7 if input interference is at the mask level. NB interference mask is not represented because, as it will be shown later on, CW mask encompasses it at frequencies of interest. Regarding Pulsed interferences with power above CW mask (which is, out-of-band, around 5 dB under the compression point of the preamplifier), they lead to saturation with unpredictable spectral effects. This is true also for classical receiver architectures, where they get no special processing. So we also propose to not consider their spectral content in the design of the RF Front-End and that is why they are not on the drawing as well.

This spectral content is then the maximum spectral content to be considered at the input of the ADC. From Figure 7 we also propose to set the useful E5 and E1 bands to respectively  $[f_{\min 5}, f_{\max 5}] = [1166.45, 1211.14]$  MHz and  $[f_{\min 1}, f_{\max 1}] = [1565.42, 1585.42]$  MHz as they are considered as the most sensitive part of the spectrum.

### 3. Sampling strategy

The challenge is to sample the input signals without worsening the interference threat over the E1 and E5 bands compared to a traditional receiver. Indeed there is no requirement for current receivers to provide measurement within specifications in the presence of interference levels higher than the limits specified in-band, provided integrity is ensured. That is to say that, unless better demodulation techniques are found, compared to the mask absolutely no increase of the in-band interference levels due to sampling is allowed. As ideal sampling is equivalent to periodic spectral aliasing, it means in other words that no in-band folding of Figure 7 is tolerated.

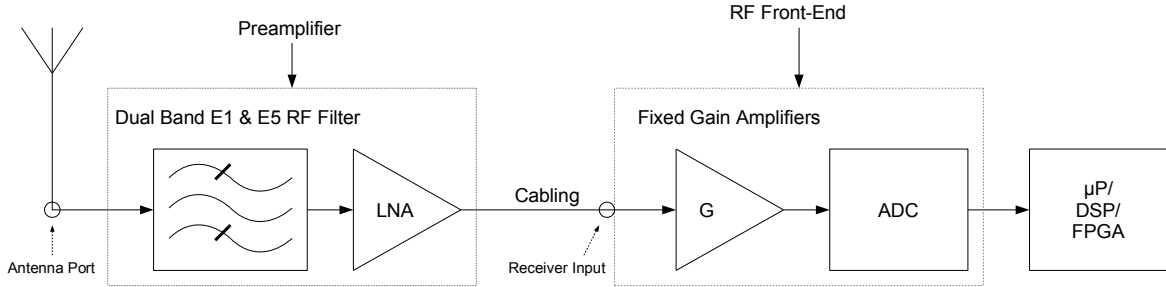

Figure 3. Ideal Direct Sampling GNSS receiver for Civil Aviation

In particular, the idea of superposing the E1 and E5 bands through subsampling as proposed in [5] must be discarded : when folded on the E5 band, the E1 signal would have to sustain a maximum level of CW interference of -103 dBm when it is supposed to bare only -118 dBm.

At this point of the study, we can conclude graphically that the only choice is to sample or subsample the [1166.45, 1585.42] MHz bandwidth as a unique block, with no aliasing. This leads to  $f_s > 3170.84$  MHz for classical sampling and  $f_s$  in [1056.95, 1166.45] MHz and [1585.42, 2332.9] MHz for subsampling. These values are of little interest compared to classical architectures at the present time or in the near future, due to the out of reach induced processing workload downstream. Without modification the scheme 3 reaches a deadlock.

Obviously, if a lower sampling frequency is desired, some extra filtering is needed in order to be able to fold filtered part of the spectrum over the E1 and E5 bands without damage during subsampling. This conclusion implies that a new architecture is needed for the proposed Direct Sampling GNSS Receiver for Civil Aviation, as shown on Figure 4.

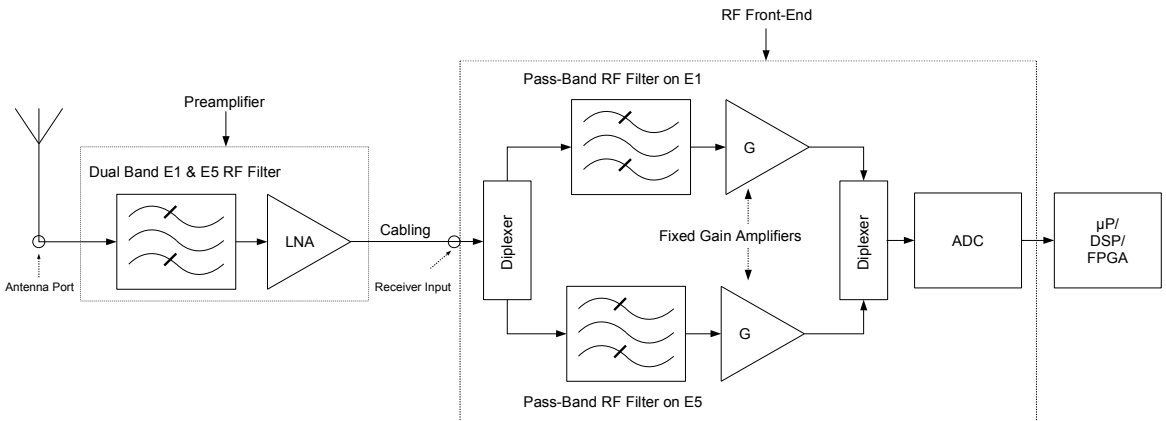

Figure 4. Direct Sampling architecture with extra filtering

In order to allow as greater aliasing as possible to reduce the sampling frequency, these filters should ideally lower out-of-band mask levels below in-band mask levels. And even more, out-of-band max levels should be reduced under the lowest in-band mask level, that is -118 dBm, corresponding to the E1 band max tolerable level. The ideal frequency response of these filters can be found in Figure 8. It includes a margin of 10 dB below -118 dBm, i.e. out-of-band mask levels are attenuated to -128 dBm, so that out-of-band interference power put back in-band can be neglected in comparison to the original in-band level.

Of course real filters present larger transition bands than the ones drawn in Figure 8. Table 1 lists the set of sampling frequencies corresponding to increasing transition bandwidths  $B$ , by step of 1 MHz. The calculations are made so that the useful bands,  $[f_{\min 5}, f_{\max 5}]$  and  $[f_{\min 1}, f_{\max 1}]$ , enlarged by transition bands at each side,  $[f_{\min 5}-B, f_{\max 5}+B]$  and  $[f_{\min 1}-B, f_{\max 1}+B]$ , do not overlap by aliasing. The 0 MHz case is given as a bound. An interesting conclusion is that there is no solution above 16 MHz transition bandwidth. And as a summary Figure 5 shows the minimum sampling frequency as a function of the transition bandwidth.

To conclude this part about the sampling strategy, we dismiss in particular the idea proposed in [5] of “digging a hole” in the middle of the E5 band, between the spectrum of the E5a signal and the one of the E5b signal, in order to alias the E1 band within it. The required transition bandwidths are definitely beyond reach even if the E1 band is reduced to its narrower part,  $1575.42 \text{ MHz} \pm 1 \text{ MHz}$  corresponding to the legacy C/A signal.

Transition Bandwidth	0	1 MHz	2 MHz	3 MHz	4 MHz	5 MHz
Sampling Frequencies $f_s$ (MHz)	[352.316, 354.280]	[317.284, 332.986]	[317.484, 332.700]	[317.684, 332.414]	[317.884, 332.129]	[318.084, 331.843]
	[317.084, 333.271]	[310.951, 312.884]	[311.173, 312.684]	[311.396, 312.484]	[311.618, 312.284]	[311.840, 312.084]
	[310.729, 313.084]	[303.035, 303.319]	[288.622, 291.113]	[288.804, 290.863]	[288.985, 290.613]	[289.167, 290.363]
	[302.785, 303.541]	[288.440, 291.363]	[280.056, 284.258]	[280.256, 284.076]	[280.456, 283.895]	[280.656, 283.713]
	[288.258, 291.613]	[279.856, 284.440]	[269.587, 272.787]	[269.809, 272.587]	[270.031, 272.387]	[270.253, 272.187]
	[279.656, 284.622]	[269.364, 272.987]	[254.596, 258.767]	[254.778, 258.544]	[254.960, 258.322]	[255.142, 258.100]
	[269.142, 273.187]	[254.415, 258.989]	[244.218, 247.988]	[244.372, 247.806]	[244.526, 247.625]	[244.680, 247.443]
	[254.233, 259.211]	[244.065, 248.170]	[226.774, 227.322]	[226.917, 227.156]	[220.935, 223.060]	[221.116, 222.917]
	[243.911, 248.352]	[226.631, 227.489]	[220.571, 223.346]	[220.753, 223.203]		
	[233.047, 233.290]	[220.389, 223.489]				
	[226.489, 227.656]	[164.621, 164.676]				
	[220.207, 223.631]	[151.518, 151.659]				
	[176.158, 177.140]					
	[164.504, 164.781]					
[155.364, 155.527]						
[151.393, 151.771]						
Transition Bandwidth	6 MHz	7 MHz	8 MHz	9 MHz	10 MHz	11 MHz
Sampling Frequencies $f_s$ (MHz)	[318.284, 331.557]	[318.484, 331.271]	[318.684, 330.986]	[318.884, 330.700]	[319.084, 330.414]	[319.284, 330.129]
	[289.349, 290.113]	[289.531, 289.863]	[281.256, 283.167]	[281.456, 282.985]	[281.656, 282.804]	[281.856, 282.622]
	[280.856, 283.531]	[281.056, 283.349]	[270.920, 271.587]	[271.142, 271.387]	[256.051, 256.989]	[256.233, 256.767]
	[270.476, 271.987]	[270.698, 271.787]	[255.687, 257.433]	[255.869, 257.211]	[245.449, 246.534]	[245.603, 246.352]
	[255.324, 257.878]	[255.505, 257.656]	[245.142, 246.897]	[245.295, 246.715]	[222.025, 222.203]	
	[244.834, 247.261]	[244.988, 247.079]	[221.662, 222.489]	[221.844, 222.346]		
[221.298, 222.774]	[221.480, 222.631]					
Transition Bandwidth	12 MHz	13 MHz	14 MHz	15 MHz	16 MHz	17 MHz
Sampling Frequencies $f_s$ (MHz)	[319.484, 329.843]	[319.684, 328.280]	[319.884, 326.280]	[320.084, 324.280]	[320.284, 322.280]	
	[282.056, 282.440]	[282.256, 282.258]				
	[256.415, 256.544]	[245.911, 245.988]				
	[245.757, 246.170]					

Table 1. Sampling Frequencies  $f_s$  vs Transition Bandwidth  $B$

#### 4. Quantization

To assess the quantization problem, we must first of all determine the extreme levels of the signal at the input of the ADC. This signal is composed of the useful signals, the system noise and possible interferences.

[4] specifies the interference masks, but also assesses the system noise through the equivalent temperature of the noise at the antenna port,  $T_{\text{sky}} = 100^\circ \text{ K}$  and the actual cable temperature,  $T = T_0 = 290^\circ \text{ K}$ . Combined to the specified preamplifier gain  $G \in [26.5, 32.5] \text{ dB}$ , its noise factor  $F = 4 \text{ dB}$  and the cable losses  $L \in [3, 13] \text{ dB}$ , it gives a noise density level  $N_0 = kG(T_{\text{sky}} + (F-1)T_0)/L + k(1-1/L)T \in [-157.7, -141.8] \text{ dBm/Hz}$  at the receiver input. Summed up over the two useful bandwidths, it leads to a system noise power of  $P_{\text{noise}} \in [-79.6, -63.7] \text{ dBm}$  at the input of the ADC. However these figures do not take into account the noise contribution of the fixed gain amplifiers required at the outputs of the extra filters to reach the full scale of the quantifier. This will be discussed hereafter.

The same document also determines the power at the antenna port of the different Open Service signals :

- $P_{LIF} \in [-157, -150]$  dBW for the L1F signal lying in the E1 band,
- $P_{E5a/b} \in [-155.7, -148.7]$  dBW for each E5a and E5b signals, lying in the E5 band.

At the receiver input it gives  $P_{LIF} \in [-113.5, -90.5]$  dBm and  $P_{E5a/b} \in [-112.2, -89.2]$  dBm.

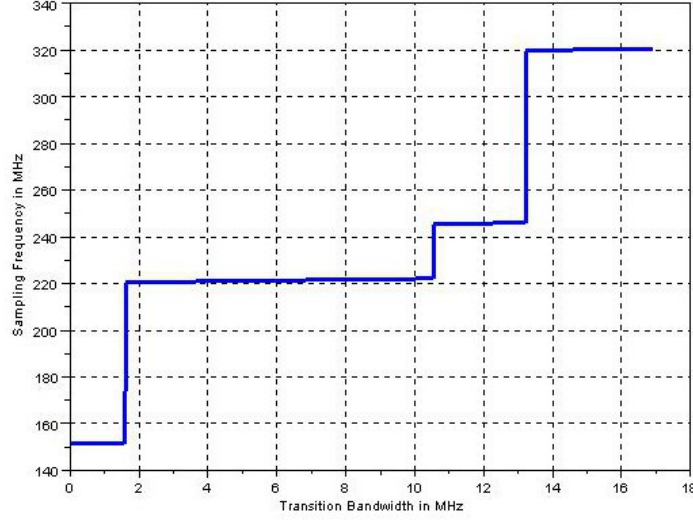

Figure 5. Minimum Sampling Frequency  $f_s$  vs Transition Bandwidth  $B$

Considering the interferences mask, we can deduce from Figure 7 that :

- whatever the transition band of the extra filters added in part 3, the maximum power level  $P_5$  of a CW interference at the output of the E5 channel is in-band and  $P_5 \in [-16.5, -0.5]$  dBm.
- At the output of the E1 channel this level  $P_1$  depends strongly on this transition band. We propose to consider the worst case, that is the level present at 1525 MHz without attenuation, -41.5 dBm. Including preamplifier gain and cable losses it lies in  $P_1 \in [-28, -12]$  dBm at the receiver input.

In the minimum power  $P_1 = -28$  dBm resides the justification of the assumption made about NB interference mask in part 2. It is much higher than the highest NB interference level in both bands, -89 dBm.

From the above figures we can conclude that :

- in the absence of interference, that is the nominal situation, the useful signals are completely buried in the system noise so that noise is the signal to consider to scale the quantifier. Regarding this aspect, under the classical assumption that the system noise can be modeled as a gaussian random process, the pertinent value is its standard deviation  $\sigma \in [23.4, 146]$   $\mu\text{V}$  over 50  $\Omega$ . Writing  $\Delta$  the quantifier step size and  $k$  the number of bits to use in order to quantize the (useful signals +) noise amplitude over  $[-3\sigma, +3\sigma]$ , we have  $2^k \Delta > 6\sigma$ . This segment is proposed as the dimensioning element because the cumulative probability of the amplitude to lie in  $[-3\sigma, +3\sigma]$  is above 99%.
- if we limit the aggression to one CW at a time per band, as the tests imposed in [4] suggest it, the maximum amplitude of the summed interference can reach  $A \in [60, 378]$  mV over 50  $\Omega$ . With  $n$  the number of bits to be used to quantize the signal in this worst situation :  $2^n \Delta > 2(A + 3\sigma)$ . As  $n > k$ ,  $n$  also sets the number of bits of the quantifier.

The proposed architecture aims in being “aircraft installation independent”, so it must copes with the full range of preamplifier gain and cable losses. It means we have to consider that the definitive dimensioning values are :

- $\sigma = \sigma_{\min} = 23.4\mu\text{V}$  over 50  $\Omega$  for the nominal situation,
- $A = A_{\max} = 378$  mV and  $\sigma = \sigma_{\max} = 146 \mu\text{V}$  over 50  $\Omega$  for the worse situation.

The relation between  $k$  and  $n$  is then  $n - k > \log_2 (A_{\max}/3\sigma_{\min} + \sigma_{\max}/\sigma_{\min})$ . It gives  $n - k > 12.40$  and  $n = 14, 15, 16, 17, 18$  for  $k = 1, 2, 3, 4, 5$  as considered in [9].

We can finally remark that  $\log_2 (A_{\max}/3\sigma_{\min} + \sigma_{\max}/\sigma_{\min}) \approx \log_2 (A_{\max}/3\sigma_{\min})$  as  $A_{\max} \gg \sigma_{\max}$ . This means that the noise contribution of the amplifiers mentioned previously, as it increases  $\sigma_{\min}$ , reduces the number of required bits. The values calculated above can then be considered as a bound.

## 5. Conclusions

In summary we have proposed an architecture for a Direct Sampling GNSS receiver designed for the E5/L5 and E1/L1 bands and intended for Civil Aviation usage. The specific interference environment to be sustained was first described in the form of masks at the antenna port. It was then refined, using the minimum frequency response requirement of the specified active antenna, into a CW mask at the receiver input. On this basis an analysis showed that some extra filters are needed to directly sample the signals with an acceptable sampling frequency. The minimum frequency response of the required filters were determined, and sets of sampling frequencies corresponding to different transition bandwidths were calculated. Next the signal dynamic between the system noise, the useful signals and the possible interferences was established, which finally led to a relation between the number of bits used to quantize the useful signals and the total number of bits needed for the quantifier.

Future work will focus on the assessment of the sampling jitter which may be a dimensioning factor due to the high sampling frequencies involved in the proposed architecture.

## References

- 1, Minimum Operational Performance Standards for Global Positioning System / Wide Area Augmentation System Airborne Equipment, RTCA, 2006
- 2, Minimum Operational Performance Standards for Global Positioning System / Aircraft Based Augmentation System Airborne Equipment, RTCA, 2009
- 3, Minimum Operational Performance Standards for GPS Local Area Augmentation System Airborne Equipment, RTCA, 2008
- 4, Minimum Operational Performance Specification for Airborne Open Service Galileo Satellite Receiving Equipment, EUROCAE, 2010
- 5, A Direct Sampling Digital Receiver for Multiple GNSS Signals, Asier Alonso, Jean-Michel Perre, Inigo Arizaga, ENC GNSS, 2008
- 6, Design of a GPS and Galileo Multi-Frequency Front-End, Enrique Rivera Parada, Frédéric Chastellain, Cyril Botteron, Youssef Tawk, Pierre-André Farine, 69th IEEE Vehicular Technology Conference, 2009
- 7, Assessment of Radio Frequency Interference Relevant to the GNSS L1 Frequency Band, RTCA, 2008
- 8, Assessment of Radio Frequency Interference Relevant to the GNSS L5/E5A Frequency Band, RTCA, 2004
- 9, Global Positioning System : Theory and Applications, A. J. Van Dierendonck, 1996

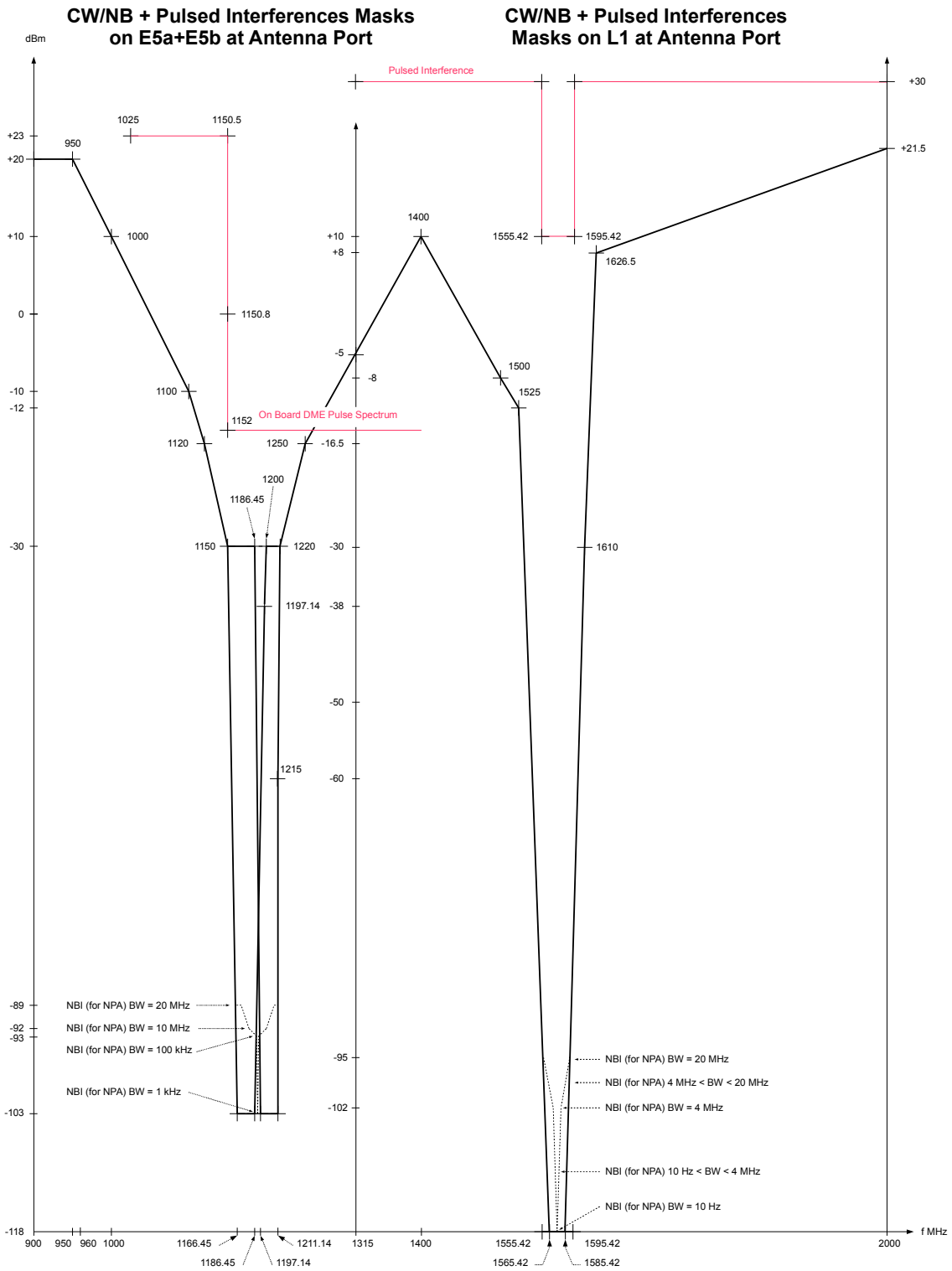

Figure 6. CW/NB and Pulsed interference masks at antenna port [4]



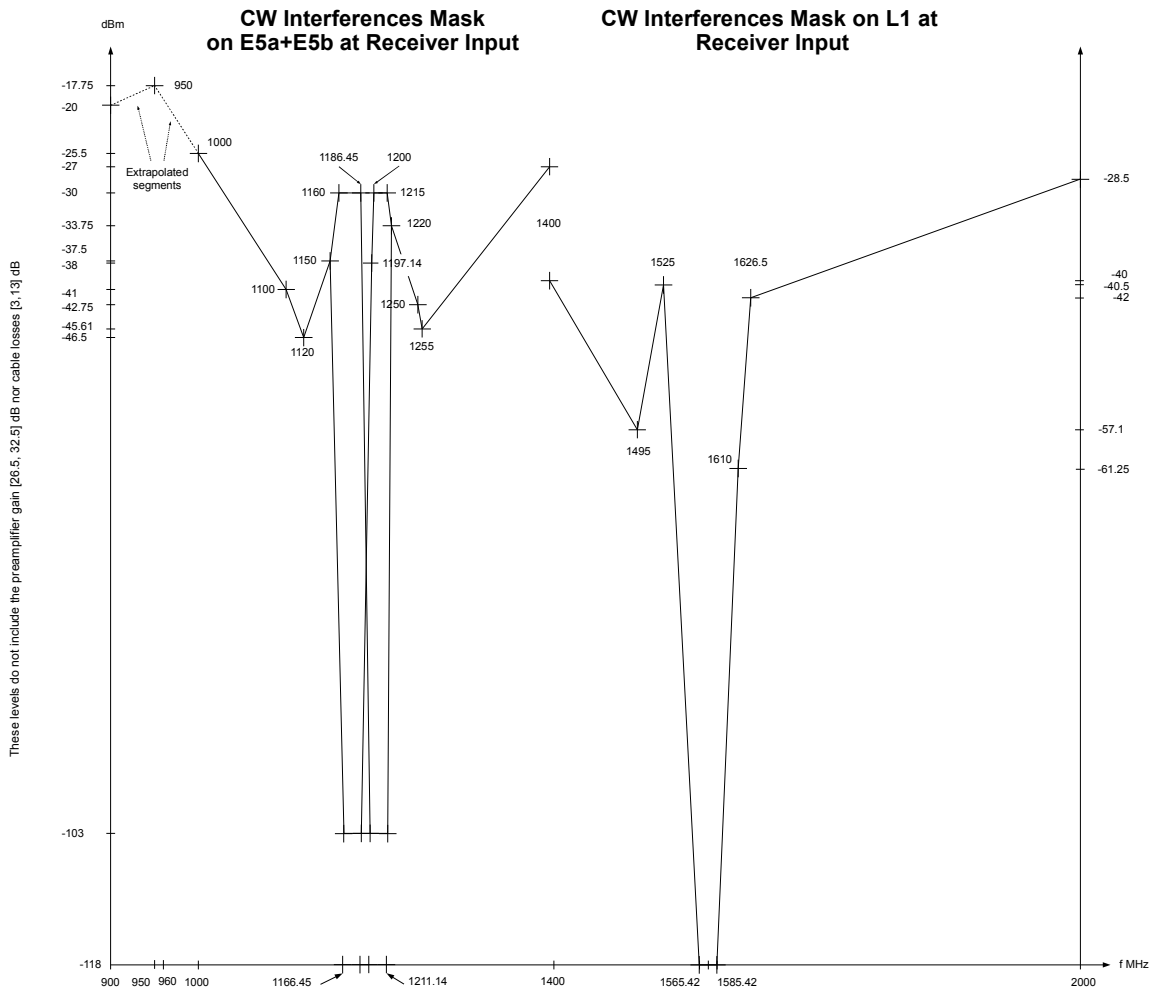

Figure 7. CW interference mask at receiver input

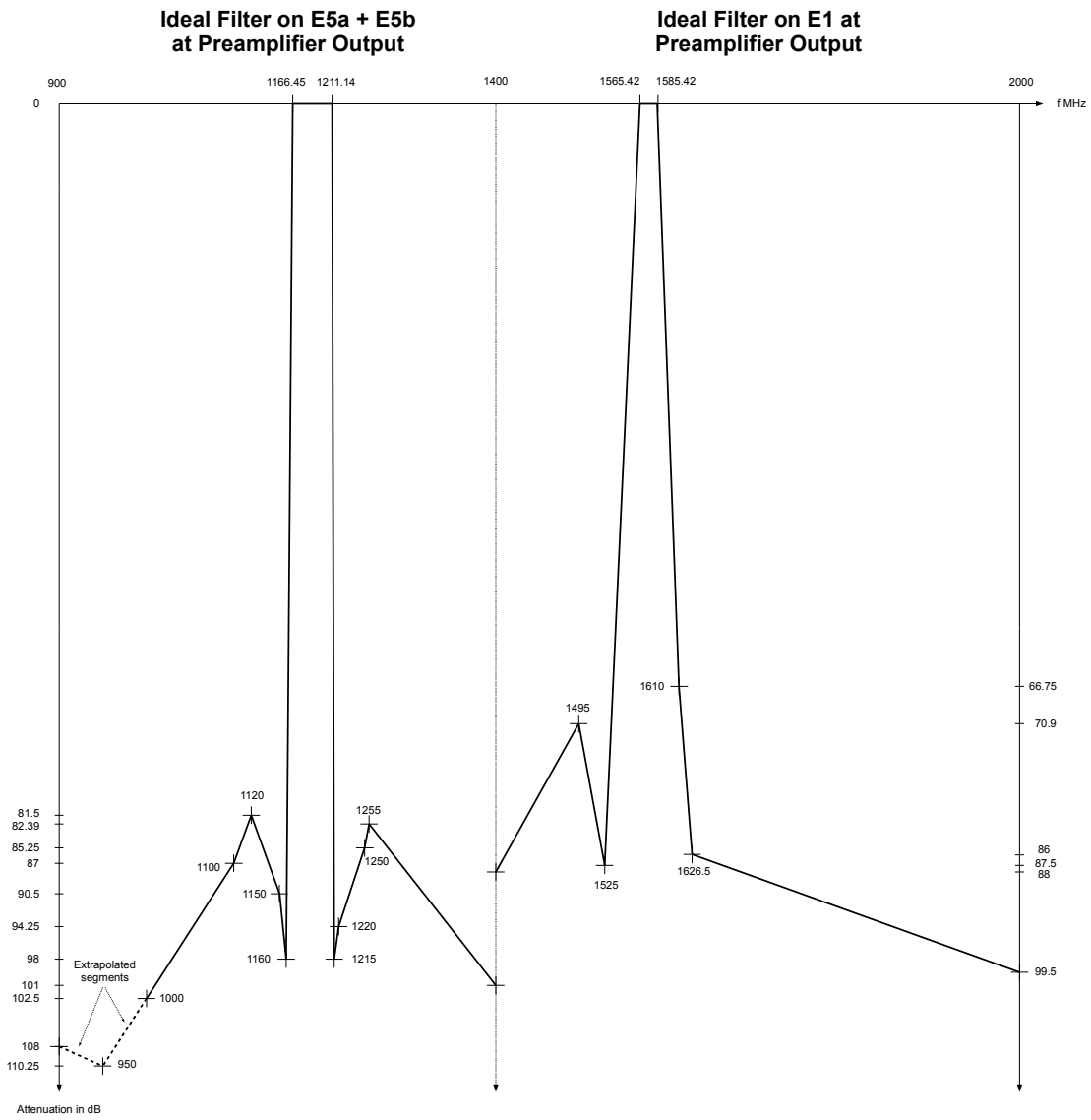

Figure 8. Ideal frequency response of the extra filters