

Slot planar antenna on metallic support with large bandwidth

Christophe Morlaas, Bernard Souny, Alexandre Chabory

► **To cite this version:**

Christophe Morlaas, Bernard Souny, Alexandre Chabory. Slot planar antenna on metallic support with large bandwidth. EUCAP 2011, 5th European Conference on Antennas and Propagation, Apr 2011, Rome, Italy. pp 475-479. hal-01067148

HAL Id: hal-01067148

<https://hal-enac.archives-ouvertes.fr/hal-01067148>

Submitted on 23 Sep 2014

HAL is a multi-disciplinary open access archive for the deposit and dissemination of scientific research documents, whether they are published or not. The documents may come from teaching and research institutions in France or abroad, or from public or private research centers.

L'archive ouverte pluridisciplinaire **HAL**, est destinée au dépôt et à la diffusion de documents scientifiques de niveau recherche, publiés ou non, émanant des établissements d'enseignement et de recherche français ou étrangers, des laboratoires publics ou privés.

Slot planar antenna on metallic support with large bandwidth

C. Morlaas*, B.Souny*, A. Chabory*

* LETA , URE-CNS, ENAC

7 av. E. Belin 31055 Toulouse France,

morlaas@enac.fr, souny@enac.fr, chabory@enac.fr.

Abstract—In this paper, we design a slot planar antenna with a low profile above a metallic support using the tools of periodic structures. A parametric study on its bandwidth performances is performed. Good results are obtained in terms of bandwidth (7%) and radiation pattern. A good trade-off between low profile, lateral size and bandwidth is found.

I. INTRODUCTION

Low profile antennas with good performances above a metallic support present a great interest for some applications like on-board antennas or RFID tags. Such antennas can be achieved by using structures based on metamaterial properties [1], [2]. Another way is to use a magnetic antenna [4]. A more sophisticated antenna using a special combination of magnetic and electric antennas to perform better performances can also be considered [3]. The realization of these antennas are relatively costly and present a not negligible thickness.

This paper presents a slot planar antenna above a metallic support (two patches separated by a gap). The design of this antenna is realized using the Bloch-Floquet theory [7].

This paper is organized as follows. Firstly an explanation of why this antenna is inspired from metamaterials is given. Secondly we explain the operating principle of this antenna. Then, the design is developed including the feeding. Finally, we perform numerical tests among which a parametric study on the bandwidth performances, and simulations on the adaptation and radiation properties.

II. INFINITE PERIODIC STRUCTURE

antenna.

A. Metamaterial assumption

We consider in this article a finite periodic structure composed by an FSS above a metallic plane, which is called here the pseudo-FSS cavity.

To analyze a structure using metamaterial techniques, two conditions are required: the dimension of the cells must be small with respect to the wavelength, and the number of cells must be great enough so as to consider the structure as periodic [5]. Upon these conditions, the tools resulting from Bloch-Floquet theory like the Floquet modes analysis or dispersion diagrams can be used.

In this article we use these tools to determine approximately which dimensions the slot antenna should have even if neither the size nor the number of cells correspond to the metamaterial

definition. This is justified if the following assumption is fulfilled. The field in the cells of the finite periodic structure excited by a realistic feeding is similar to the field in the cells of the same structure but infinite and excited by a plane wave. This will be the case if the fundamental mode of the pseudo-FSS cavity corresponds to a mode of the infinite periodic structure.

B. Dispersion diagram

First of all, we perform a modal analysis of the infinite FSS. The aim is to determine conditions under which the infinite FSS can be used efficiently as an antenna. For the sake of clarity, we consider the simplified configuration of Fig. 1. The problem is y -invariant, and periodic with respect to x . The cell size is P . The periodic boundaries at $x = 0$ and $x = P$ are characterized by a phase shift of $\exp(jk_x P + 2\pi i)$ with i the order of spatial modes.

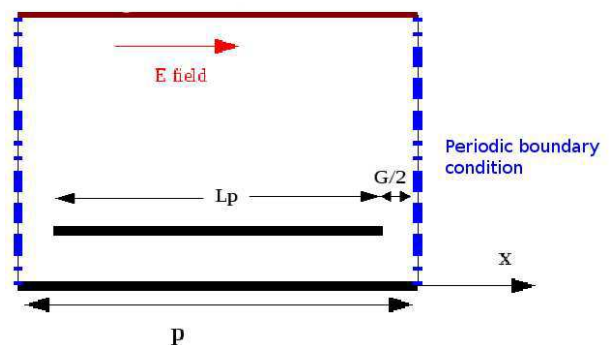

Fig. 1. Configuration of the infinite periodic structure

The i^{th} -order spatial modes of the smallest pulsation are denoted $M_{i,k_x P}$. In Fig. 2, we display the dispersion diagram of this structure for the $M_{0,k_x P}$ mode. The first Brillouin zone is limited to $k_x \in [-\frac{\pi}{P}, \frac{\pi}{P}]$. In an infinite periodic structure, the modes are continue over the variable $k_x P$. We distinguish two types of modes :

- The modes corresponding to $k_x > k_0$, with k_0 the wave number, are guided modes along x . If they are excited they will not radiating and increase the reactive energy.
- The modes corresponding to $k_x < k_0$ are leaky modes. If they are excited, they can radiate energy and thus the FSS can be used as an efficient antenna.

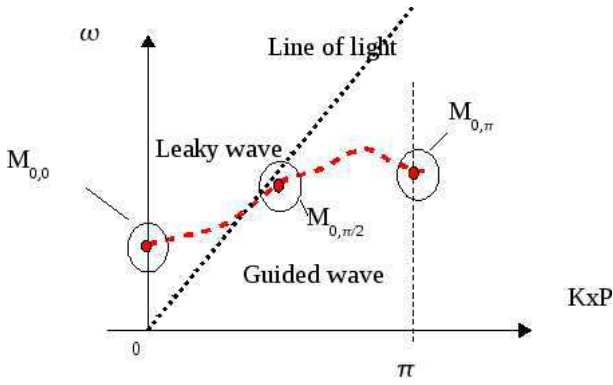

Fig. 2. Dispersion diagram

C. Antenna efficiency

We consider here the case where only the $M_{0,0}$ mode, i.e. for $k_x = 0$ is excited. For such a mode, because $k_x < k_0$, this structure can be considered as a leaky wave antenna. From the physics of the configuration, we can give the field distribution of this mode, which is represented in Fig. 3.

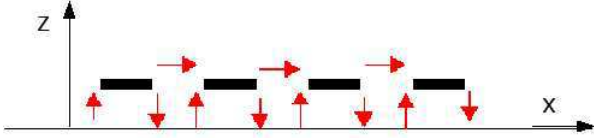

Fig. 3. Electric field of the $M_{0,0}$ mode

To evaluate the radiation of this antenna, we can use the equivalence theorem in the plane of the FSS. In each slot, we have an equivalent magnetic current given by

$$\mathbf{J}_m = -\mathbf{n} \times \mathbf{E}, \quad (1)$$

where \mathbf{n} is the outgoing normal and \mathbf{E} the electric field. There also exist electric equivalent currents, but their radiation can be neglected due to the proximity of the back metallic plane.

Therefore, the $M_{0,0}$ mode will efficiently radiate if the electric field is maximal in the plane of the FSS. This optimizes the coupling between the field inside the FSS and the field radiated outside the FSS. This is more particularly true for the field radiated towards $z \rightarrow +\infty$ because the mode is such that $k_x = 0$.

D. Design with Bloch-Floquet analysis

To take this into account when designing the FSS structure, we can employ reciprocity and reaction. We illuminate the FSS with the Bloch-Floquet mode of order 0, of amplitude E_i and such that $k_x = 0$. In the plane of the FSS, the total electric field associated with this Bloch-Floquet mode is given by

$$E_T = E_i (1 + \Gamma) \quad (2)$$

where Γ is the reflexion coefficient deembedded in the plane of the slot. This electric field is maximal for $\Gamma = +1$.

Consequently, the FSS with the $M_{0,0}$ mode excited constitutes an efficient antenna if $\Gamma = +1$ in the plane of the FSS. This reflexion coefficient corresponds to the one of an high impedance surface (HIS).

III. THE PSEUDO-FSS CAVITY

We know analyze the radiation of a truncated periodic structure based on the preceding results for the infinite FSS.

In Fig. 4, we present the antenna structure, which is composed by two patches separated by a gap (a slot). It can be seen as a truncated frequency selective surface (FSS) above a metallic plane constituted with two unit cells.

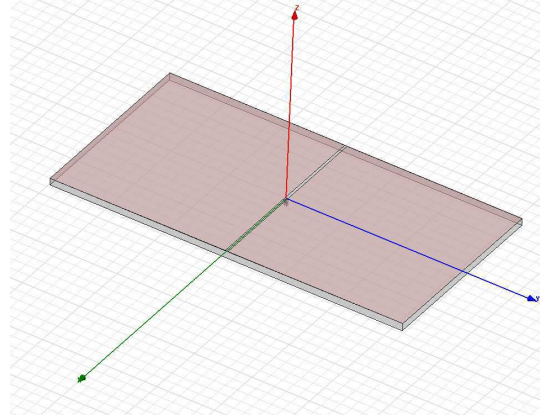

Fig. 4. Antenna structure

In the infinite periodic structure, the modes of the dispersion diagram were continue over the variable $k_x P$ (red dashed line Fig. 2).

In the case of a finite periodic structure, in the assumption there is no coupling between modes, we can consider only one eigenmode, the most excited as it is done for a slightly perturbed cavity. Then the associated phase of this eigenmode is a multiple of 2π .

For a guide constituted by N identical cells, the phase relation for a unit cell is given by $k_x P = \frac{\pi n}{N}$ with $n \in \{0, \dots, N-1\}$ and N the number of unit cells. The dispersion diagram is then discretized by a dirac comb with a period of $k_x P = \frac{\pi n}{N}$.

For only two cells, only the modes $M_{0,0}$, $M_{0,\pi/2}$ and $M_{0,\pi}$ exist. They are respectively positioned at $k_x P = 0$, $k_x P = \frac{\pi}{2}$ and at $k_x P = \pi$ of the first Brillouin zone (red point Fig. 2). The electric field of the $M_{0,0}$ mode is represented in Fig. 5.

When the number of unit cells increases, the number of possible evanescent (non-radiating) modes increases. Thus the reactive energy may increase. This may explain a bandwidth reduction when the number of cells increases.

Besides, due to the feeding, the equivalent currents in each slot may have a non-uniform amplitude. This may be explained by the excitation of higher-order spatial modes ($M_{i,0}$ with $i > 1$). This is another reason why a realistic feeding will decrease the bandwidth.

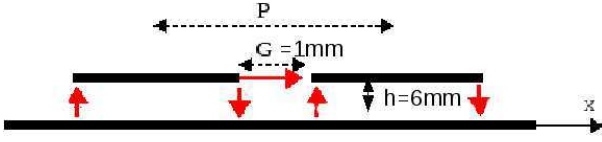

Fig. 5. Electric field of the $M_{0,0}$ mode in the pseudo-FSS cavity

Due the main contribution of the $M_{0,0}$ mode, the radiation efficiency is almost unchanged for two cells in comparison with the infinite structure. Nevertheless, the operating frequency and the bandwidth are modified. The shift of the operating frequency depends on the coupling of the feed with the structure.

IV. DESIGN

A first estimation of the dimensions of this structure is obtained via the use of the Floquet mode analysis. We search to have $\Gamma = +1$ in the plane of the FSS at the operating frequency. To obtain the final antenna dimension, the complete antenna is simulated with its realistic feeding probe.

The feed must be chosen so as to correctly excite the $M_{0,0}$ mode. This can be achieved via different ways. A technique is to use an electric dipole above or into the structure. This is similar to what is done when an antenna is placed over an HIS surface [8]. Another technique is to use an electric probe into the slot to excite the electric field of the mode or an electric loop into the thickness of the structure to excite the magnetic field of the mode.

V. NUMERICAL EXPERIMENTS

A. Design analysis

We aim at finding the unit cell dimensions which yield an antenna of operating frequency 1.57GHz. To do so, we set the gap and the thickness (h) at 1mm and 6mm, respectively. We start with a Floquet modal analysis. We search the patch length and width for which the reflexion coefficient of the first Floquet mode deembedded in the plane of the pseudo-FSS is equal to +1 at 1.57GHz. This reflexion coefficient corresponds to the one of a perfect magnetic conductor (PMC) and is reached for a patch length and width of 57mm and 55mm, respectively.

According to the criterion of [6], the bandwidth of the HIS corresponds to phase variations of the reflexion coefficient around 0° of $\pm -90^\circ$. From Fig. 6, we obtain a bandwidth of 300MHz (19%).

B. Antenna analysis

Because of the finiteness (truncation) of the pseudo-FSS, and the coupling by a localized probe, this operating frequency is shifted towards a higher frequency. To obtain the final patch length, we consider the complete antenna (Fig. 5) and we adjust the length until the resonant frequency of the fundamental mode of this cavity is at 1.57GHz. This corresponds to a patch length of 67mm. The gap, the width and the thickness are unchanged.

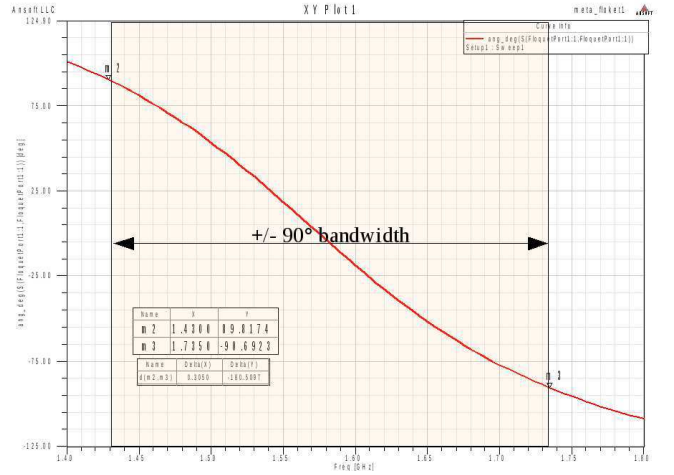

Fig. 6. Bandwidth of the periodic structure via Floquet analysis

The feeding can be realized with two probes on both parts of the gap to obtain differential excitation via a balun. The principal interest of such a feeding is to use the benefit of differential modes in active components to prevent noise. Nevertheless, for classical applications which do not need differential feeding, a single feed can also be used, as is commonly done for patch antennas.

C. Parametric analysis

A parametric analysis is performed on the thickness of the antenna. The operating frequency is very sensitive to the thickness of the pseudo-FSS. The frequency increases from 1.57GHz to 1.955GHz for a thickness variation from 6mm to 2mm as shown in Fig. 7.

This frequency shift can be compensated either by increasing the length of the patches or by keeping the length of the patches constant and increasing the distributed capacity of the slot. It can be done by adding some discrete capacitors distributed along the slot or by designing an interdigital capacitor in the slot.

We display in Fig. 8 the bandwidth at 1.57GHz with regards to the antenna thickness. The bandwidth is here defined as $VSWR < 2$ for a matching impedance of 50Ω . The length or capacitor values are adjusted so as to keep the same operating frequency. We observe that the bandwidth is reduced when the thickness is reduced. The red dashed line corresponds to a variation of the patch length and thickness from 67×6 mm to 88×1 mm, without capacitors in the slot. The blue solid line corresponds to 10 capacitors distributed in the slot, which values vary from 0.35pF at 6mm to 2.7pF at 1mm, for a patch length fixed at 67mm.

With capacitive loading of the slot, we can obtain a small antenna in terms of thickness and length, but at the cost of a slight reduction of the bandwidth.

D. Performances

The bandwidth obtained is of 7% for a size of $(2 \times 67) \times 55 \times 6$ mm (length \times width \times thickness) and is represented in Fig.

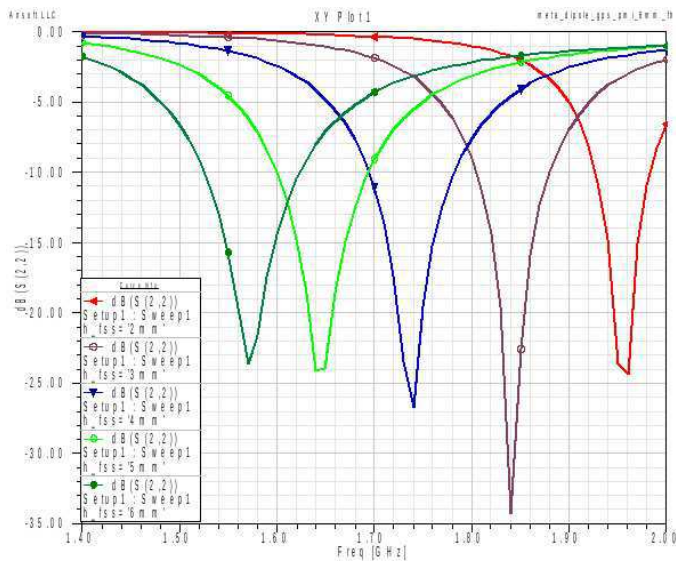

Fig. 7. $|S_{11}|$ (dB) with regards to frequency for several thicknesses

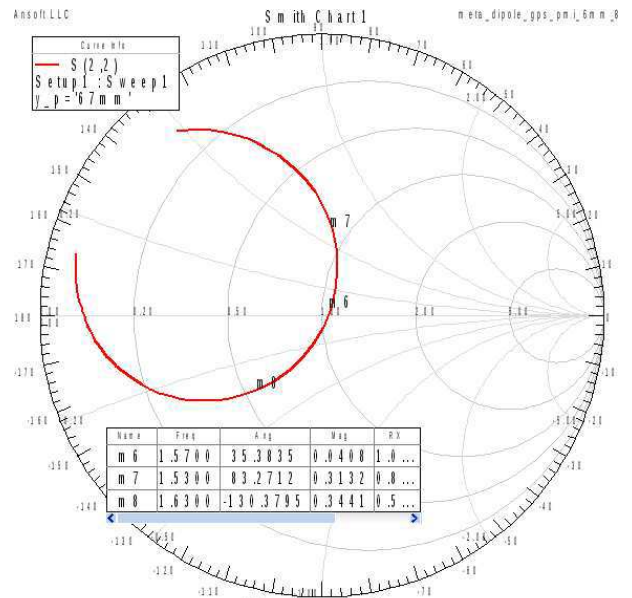

Fig. 9. Smith chart of the antenna S_{11}

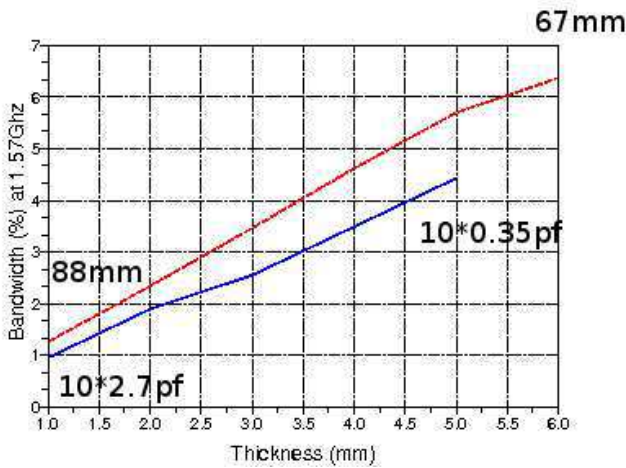

Fig. 8. Thickness effect on the bandwidth with a variation of length (red dashed line), and with ten distributed capacitors in the slot (blue solid line)

9. The 3D radiation pattern is plotted in Fig. 10. We observe a very good directivity of 7.5dB for a linear polarization.

VI. CONCLUSION

We have proposed a method to design a thin antenna over a metallic support, which is inspired from high impedance surfaces. We have used the theoretical tools of periodic structures to design and size the antenna. We have analyzed the fundamental mode of the infinite periodic structure. We have shown that this mode can radiate efficiently as a leaky wave antenna if the periodic structure can be considered as an HIS. This has rendered possible the design by means of a simple method using Floquet analysis. We have explained why this method remains valid when the structure contains only a limited number of cells.

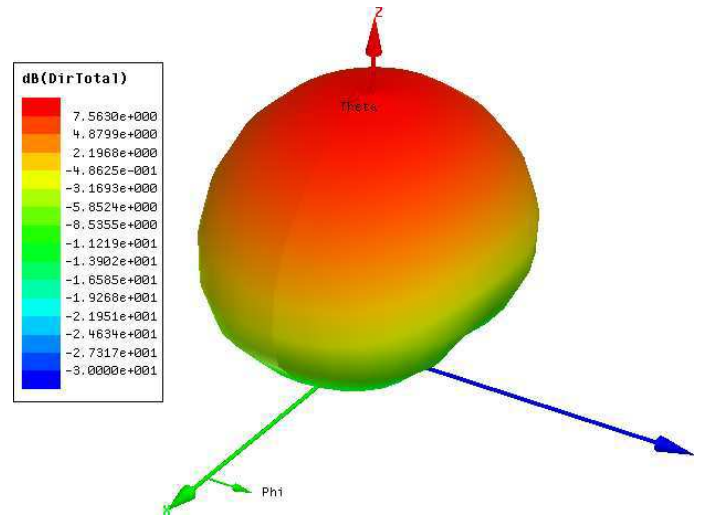

Fig. 10. Directivity pattern (dBi)

We have applied this method in order to simulate a slot antenna on a metallic support with large bandwidth properties and low thickness. We have performed a parametric analysis on the bandwidth performances, and we have proposed a solution to reduce the length for low thickness. The radiation pattern has been computed with satisfying results.

Note that this approach can be extended to multiple patch structures. Because of its good characteristics and its low-cost manufacture, this antenna may constitute a good solution for applications such as RFID sensors or GNSS systems. RF sensor applications can be envisaged due to the possibility of tuning the operating frequency by modifying the thickness or the gap size.

REFERENCES

- [1] S. Zhu, R. Langley, "Dual-Band Wearable Textile Antenna on an EBG Substrate", *IEEE transactions on Antennas and Propagation*, Vol. 57, No. 4, April 2009.
- [2] A., P. Feresidis, G. Goussetis, S. Wang, J.(Yiannis) C. Vardaxoglou, "Artificial Magnetic Conductor Surfaces and Their Application to Low-Prole High-Gain Planar Antennas," *IEEE transactions on Antennas and Propagation*, Vol. 53, No. 1, January. 2005.
- [3] B. Souny, C. Morlaas, A. Chabory, "Compact Self-Directional Antenna Based on a Helical Ring ", *IEEE Antennas and Propagation Society International Symposium (APSURSI)*, July 2010.
- [4] .M. Pigeon, C. Morlaas, H. Aubert, B. Souny, "Highly Compact Composite Antenna", *IEEE Antennas and Propagation Society International Symposium (APSURSI)*, June 2009.
- [5] R. M. Walser, "Electromagnetic Metamaterials", *Keynote adress, DARPA Workshop on Metamaterial*, Washington D. C. , November 1999.
- [6] D. Sievenpiper, L. Zhang, R.F.J. Broas, N.G. Alexopolus, and E. Yablonovitch, " High-impedance electromagnetic surfaces with a forbidden frequency band ," *IEEE Trans. Microwave Theory Tech.*, Vol. 47, November 1999.
- [7] D. Sjöberg, C. Engström, G. Kristensson, D. J.N. Wall, N. Wellander "A Floquet-Bloch Decomposition of Maxwell's Equations Applied to Homogenization ", *Society for Industrial and Applied Mathematics*, Vol. 4, is. 1, 2005.
- [8] H. Liu, K. L. Ford, R. Langley, "Miniaturised periodic structures with antenna applications," *Loughborough Antennas and Propagation Conference*, 2009.